

WEBENCH® Power Architect

Project Report

Project : 4320088/4 : PA_Project_303 (modified from 301)
 Created : 2015-08-12 01:14:38.554
 Optimize project optFactor=3

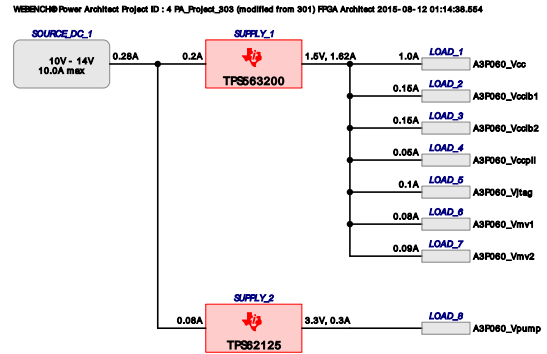

Project Summary

- | | |
|-----------------------------------|-----------------------|
| 1. Total System Efficiency | 86.224 % |
| 2. Total System BOM Count | 17.0 |
| 3. Total System Footprint | 145.0 mm ² |
| 4. Total System BOM Cost | \$2.39 |
| 5. Total System Power Dissipation | 546.4 mW |

--> Launch WEBENCH Power Architect.

Power Supplies

#	Name	NSID	Description	Vout	Iout	Efficiency	Foot-print	Cost	Design	Page
1.	SUPPLY_1	TPS563200	Switcher : 17V, 3A,6-pin, Low Iq Synchronous buck converter with Advanced Eco-mode	1.5 V	1.62 A	85.6%	74	\$1.38	26	4
2.	SUPPLY_2	TPS62125	Switcher : 3V-17V, 300mA Buck Converter With Adjustable Enable Threshold And Hysteresis	3.3 V	0.3 A	87.8%	71	\$1.01	27	9

Power Loads

#	Name	VLoad	Iload	Description
1.	A3P060_Vcc	1.5 V	1 A	VoutRipple=5%, SoftStart delay=1.0 mSec
2.	A3P060_Vccib1	1.5 V	0.15 A	VoutRipple=5%, SoftStart delay=1.0 mSec
3.	A3P060_Vccib2	1.5 V	0.15 A	VoutRipple=5%, SoftStart delay=1.0 mSec
4.	A3P060_Vccpll	1.5 V	0.05 A	VoutRipple=5%, SoftStart delay=1.0 mSec
5.	A3P060_Vjtag	1.5 V	0.1 A	VoutRipple=5%, SoftStart delay=1.0 mSec
6.	A3P060_Vmv1	1.5 V	0.08 A	VoutRipple=5%, SoftStart delay=1.0 mSec
7.	A3P060_Vmv2	1.5 V	0.09 A	VoutRipple=5%, SoftStart delay=1.0 mSec
8.	A3P060_Vpump	3.3 V	0.3 A	VoutRipple=9%, Group=Pump, SoftStart delay=1.0 mSec

FPGAs, Processors

#	Manufacturer	Part Number	Name	Series	Description
1.	Actel	A3P060	FPGA_1	ProASIC3	FPGA Actel ProASIC3 A3P060

http://www.actel.com/documents/PA3_DS.pdf

Project Diagram

WEBENCH® Power Architect Project ID : 4 PA_Project_303 (modified from 301) FPGA Architect 2015-08-12 01:14:38.554

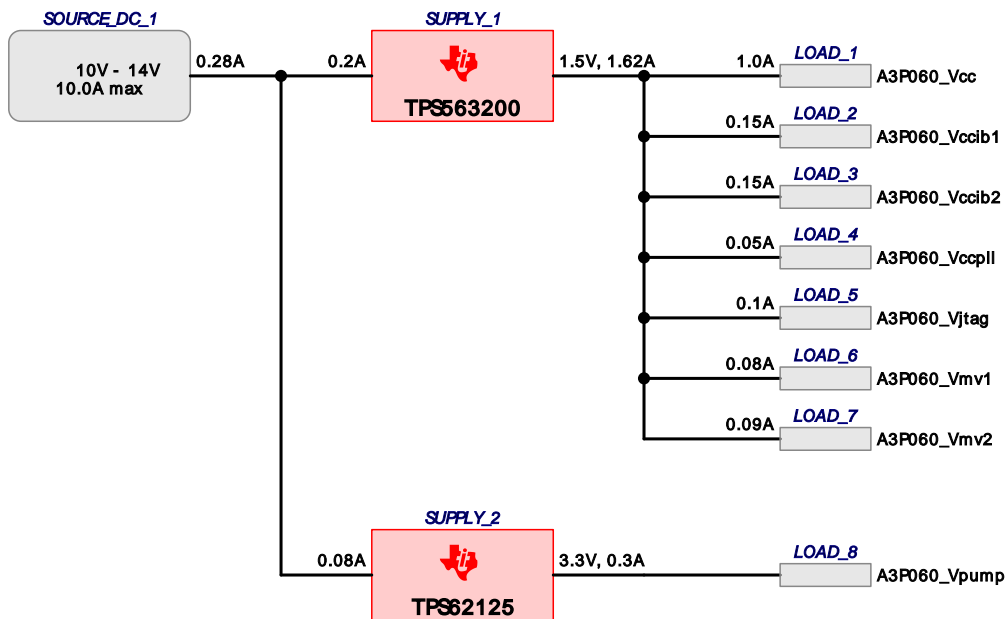

Electrical Procurement BOM

Manufacturer	Part Number	Description	Quantity	Budgetary Price	Footprint (mm ²)
AVX	08053C104KAT2A	0805	1	\$0.01	7
Kemet	C0603C106M9PACTU	0603	1	\$0.08	5
TDK	C3216X5R1C106KT	1206	1	\$0.08	11
Vishay-Dale	CRCW0402100KFKED	0402	2	\$0.01	6
Vishay-Dale	CRCW040210K0FKED	0402	1	\$0.01	3
Vishay-Dale	CRCW04021M33FKED	0402	1	\$0.01	3
Vishay-Dale	CRCW0402200KFKED	0402	1	\$0.01	3
Vishay-Dale	CRCW0402309KFKED	0402	1	\$0.01	3
Vishay-Dale	CRCW040233K2FKED	0402	1	\$0.01	3
Vishay-Dale	CRCW04029K76FKED	0402	1	\$0.01	3
MuRata	GRM31CR60J476ME19L	1206	1	\$0.12	11
MuRata	GRM32ER61E226KE15L	1210	1	\$0.16	15
Bourns	SDR0403-150ML	SDR0403	1	\$0.18	28
Texas Instruments	TPS563200DDCR	DDC0006A	1	\$0.52	10
Texas Instruments	TPS62125DSGR	S- PWSON- N8	1	\$0.61	10
Coilcraft	XFL4020-152MEB	XFL4020	1	\$0.55	25
Total			17	\$2.39	146



VinMin = 10.0V
 VinMax = 14.0V
 Vout = 1.5V
 Iout = 1.62A

Device = TPS563200DDCR
 Topology = Buck
 Created = 8/12/15 1:14:37 AM
 BOM Cost = \$1.38
 Footprint = 74.0 mm²
 BOM Count = 7
 Total Pd = 0.41W

WEBENCH® Design Report

Design : 4320088/26 TPS563200DDCR
 TPS563200DDCR 10.0V-14.0V to 1.50V @ 1.62A

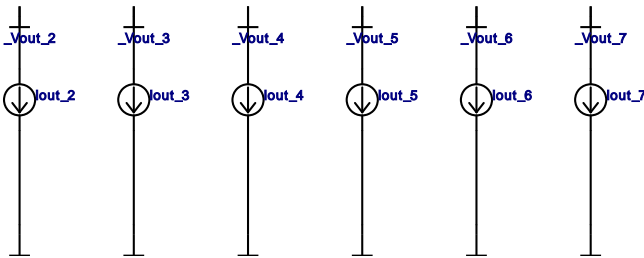
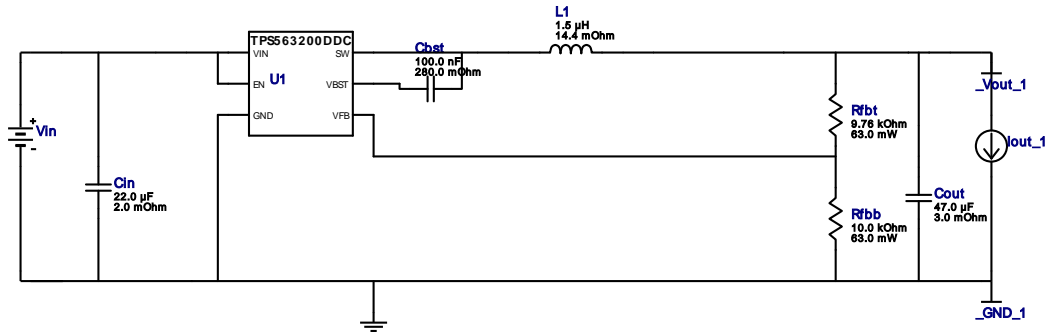

Electrical BOM

#	Name	Manufacturer	Part Number	Properties	Qty	Price	Footprint
1.	Cbst	AVX	08053C104KAT2A Series= X7R	Cap= 100.0 nF ESR= 280.0 mOhm VDC= 25.0 V IRMS= 0.0 A	1	\$0.01	0805 7 mm ²
2.	Cin	MuRata	GRM32ER61E226KE15L Series= X5R	Cap= 22.0 uF ESR= 2.0 mOhm VDC= 25.0 V IRMS= 3.67 A	1	\$0.16	1210 15 mm ²
3.	Cout	MuRata	GRM31CR60J476ME19L Series= X5R	Cap= 47.0 uF ESR= 3.0 mOhm VDC= 6.3 V IRMS= 0.0 A	1	\$0.12	1206 11 mm ²
4.	L1	Coilcraft	XFL4020-152MEB	L= 1.5 uH DCR= 14.4 mOhm	1	\$0.55	XFL4020 25 mm ²
5.	Rfbb	Vishay-Dale	CRCW040210K0FKED Series= CRCW..e3	Res= 10.0 kOhm Power= 63.0 mW Tolerance= 1.0%	1	\$0.01	0402 3 mm ²
6.	Rfbt	Vishay-Dale	CRCW04029K76FKED Series= CRCW..e3	Res= 9.76 kOhm Power= 63.0 mW Tolerance= 1.0%	1	\$0.01	0402 3 mm ²
7.	U1	Texas Instruments	TPS563200DDCR	Switcher	1	\$0.52	DDC0006A 10 mm ²

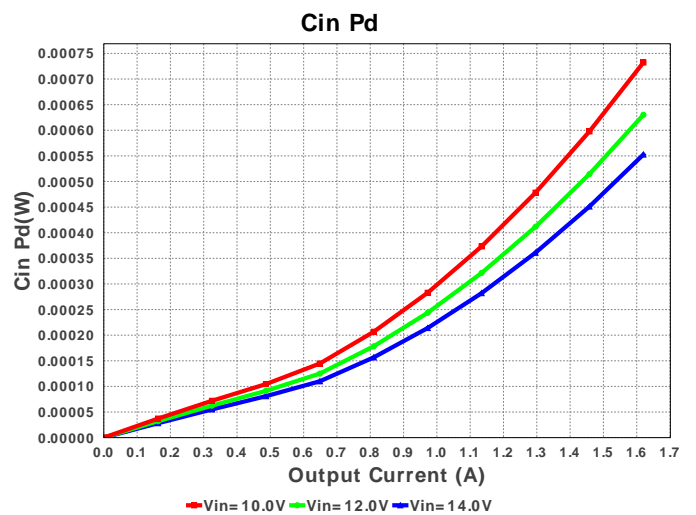
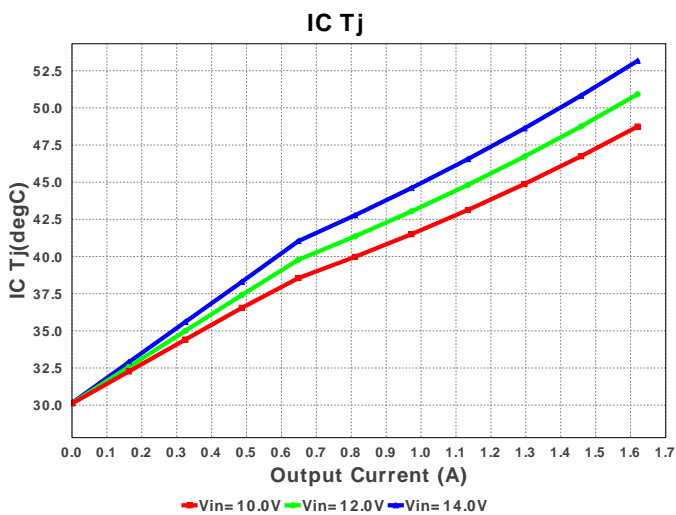
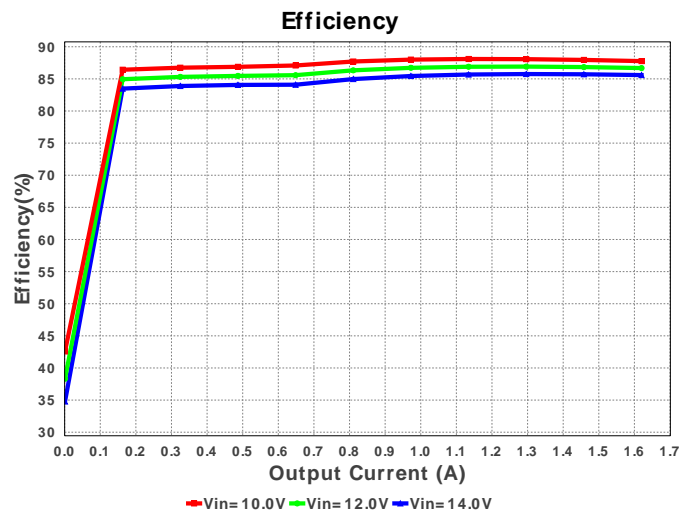
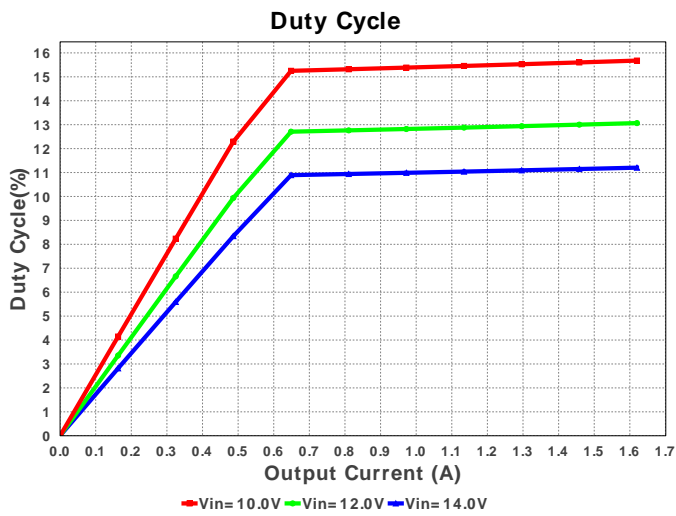
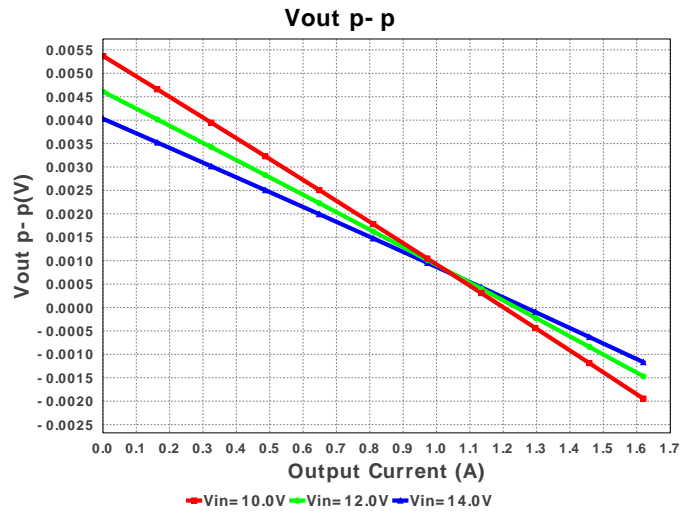
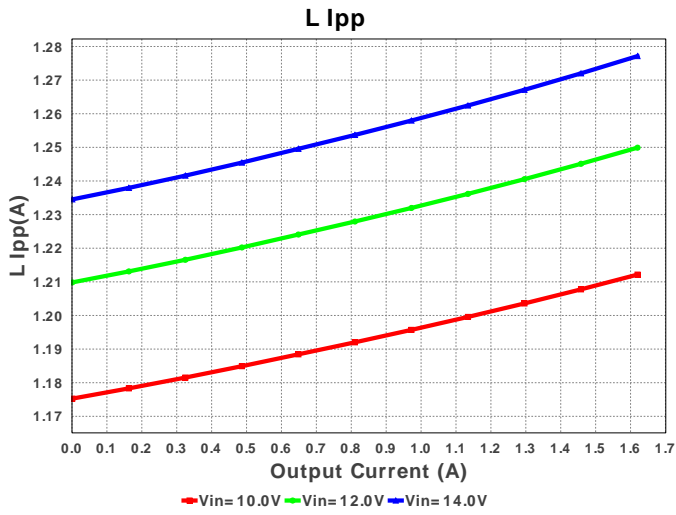

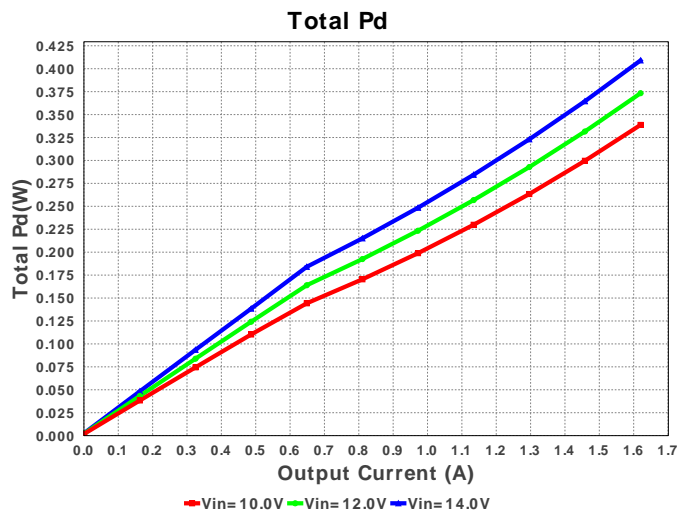
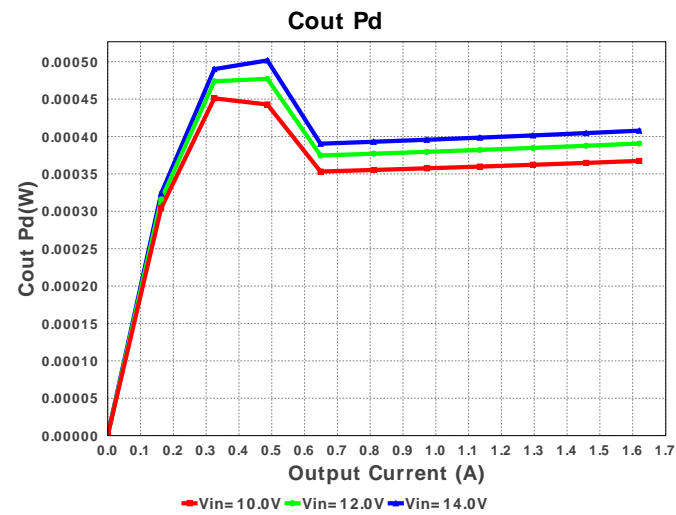
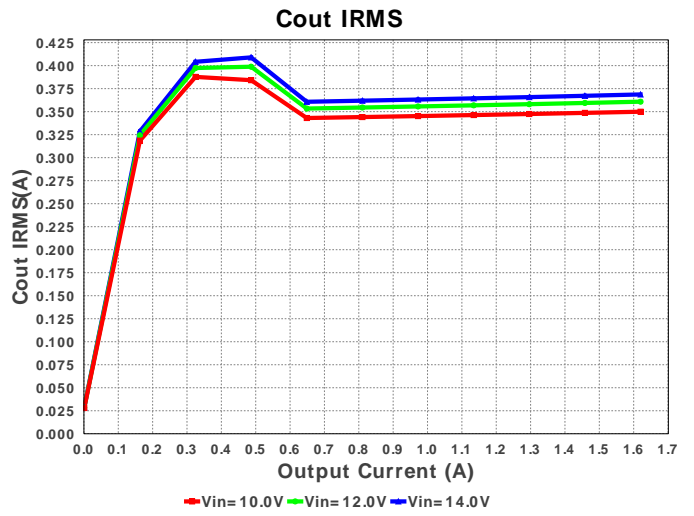
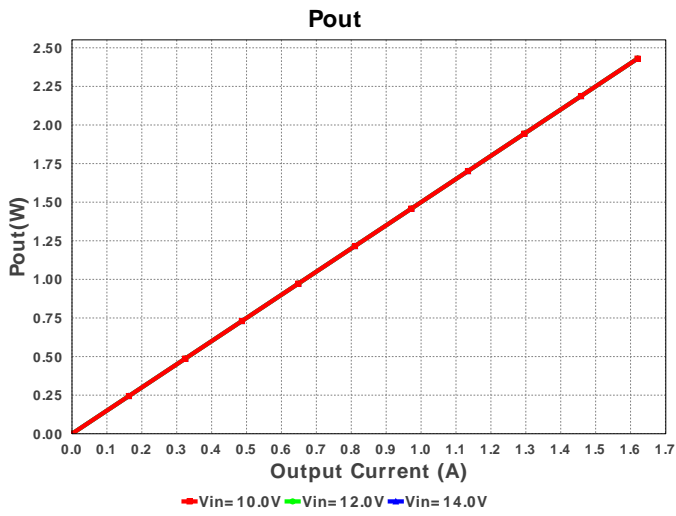
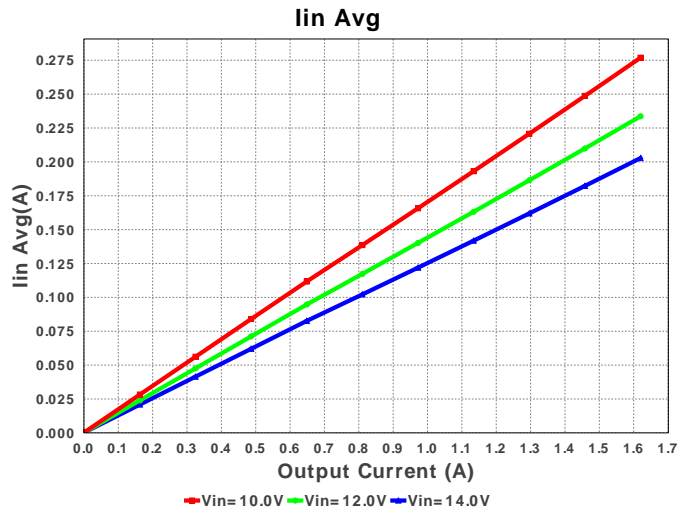
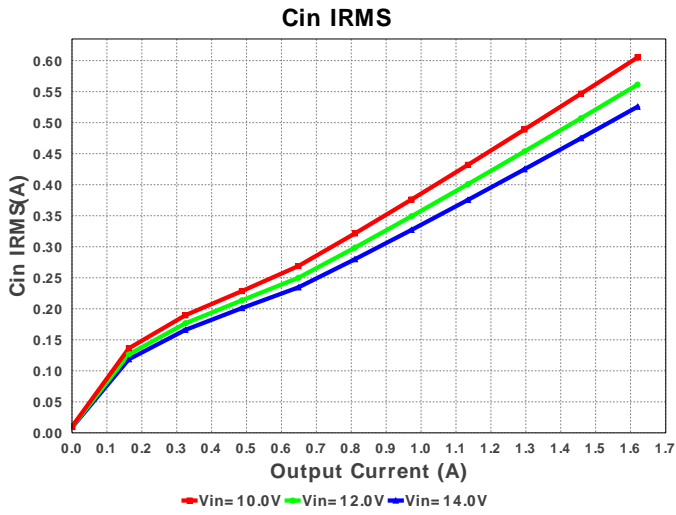

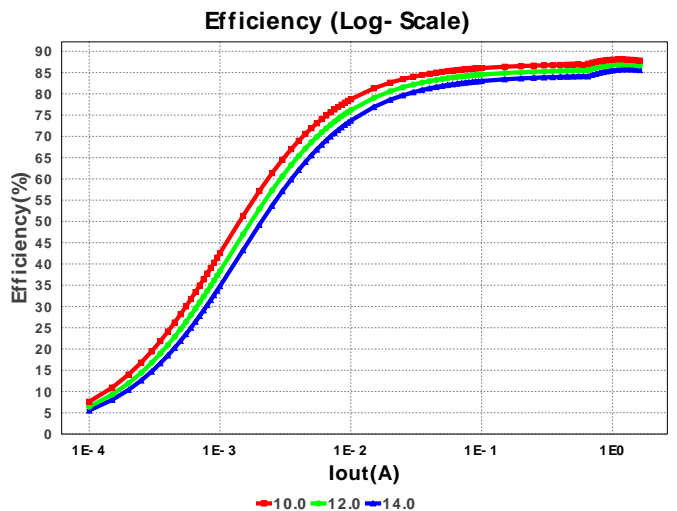
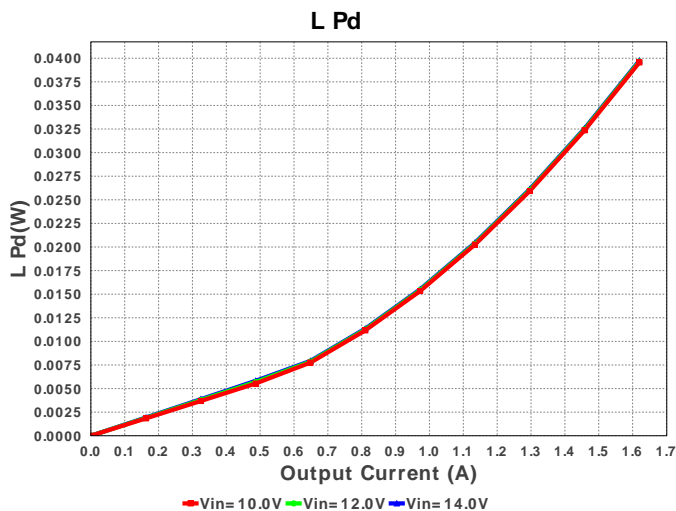
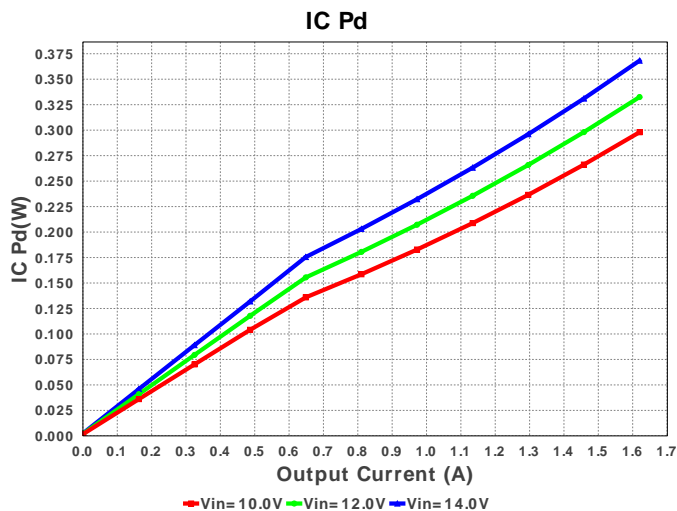
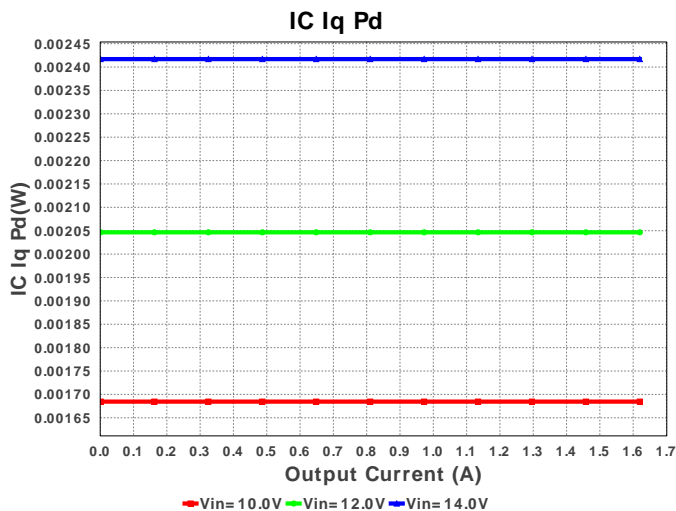

Operating Values

#	Name	Value	Category	Description
1.	Cin IRMS	525.654 mA	Current	Input capacitor RMS ripple current
2.	Cout IRMS	368.679 mA	Current	Output capacitor RMS ripple current
3.	Iin Avg	202.79 mA	Current	Average input current
4.	L Ipp	1.277 A	Current	Peak-to-peak inductor ripple current
5.	BOM Count	7	General	Total Design BOM count
6.	FootPrint	74.0 mm ²	General	Total Foot Print Area of BOM components
7.	Frequency	725.257 kHz	General	Switching frequency
8.	Pout	2.43 W	General	Total output power
9.	Total BOM	\$1.38	General	Total BOM Cost
10.	Vout OP	1.5 V	Op_Point	Operational Output Voltage
11.	Duty Cycle	11.203 %	Op_point	Duty cycle
12.	Efficiency	85.592 %	Op_point	Steady state efficiency
13.	IC Tj	53.161 degC	Op_point	IC junction temperature
14.	ICThetaJA	62.9 degC/W	Op_point	IC junction-to-ambient thermal resistance
15.	IOUT_OP	1.62 A	Op_point	Iout operating point
16.	VIN_OP	14.0 V	Op_point	Vin operating point
17.	Vout p-p	6.436 mV	Op_point	Peak-to-peak output ripple voltage
18.	Cin Pd	552.623 μW	Power	Input capacitor power dissipation
19.	Cout Pd	407.773 μW	Power	Output capacitor power dissipation
20.	IC Iq Pd	2.417 mW	Power	IC Iq Pd
21.	IC Pd	368.214 mW	Power	IC power dissipation
22.	L Pd	39.749 mW	Power	Inductor power dissipation
23.	Total Pd	409.052 mW	Power	Total Power Dissipation

Design Inputs

#	Name	Value	Description
1.	Iout	1.62	Maximum Output Current
2.	Iout1	1.62	Output Current #1
3.	SoftStart	1.0 ms	Soft Start Time (ms)
4.	VinMax	14.0	Maximum input voltage

#	Name	Value	Description
5.	VinMin	10.0	Minimum input voltage
6.	Vout	1.5	Output Voltage
7.	Vout1	1.5	Output Voltage #1
8.	base_pn	TPS563200	Texas Instruments Base Part Number
9.	source	DC	Input Source Type
10.	ta	30.0	Ambient temperature

Design Assistance

1. TPS563200 Product Folder : <http://www.ti.com/product/TPS563200> : contains the data sheet and other resources.



VinMin = 10.0V
 VinMax = 14.0V
 Vout = 3.3V
 Iout = 0.3A

Device = TPS62125DSGR
 Topology = Buck
 Created = 8/12/15 1:14:37 AM
 BOM Cost = \$1.01
 Footprint = 71.0 mm²
 BOM Count = 10
 Total Pd = 0.14W

WEBENCH® Design Report

Design : 4320088/27 TPS62125DSGR
 TPS62125DSGR 10.0V-14.0V to 3.30V @ 0.3A

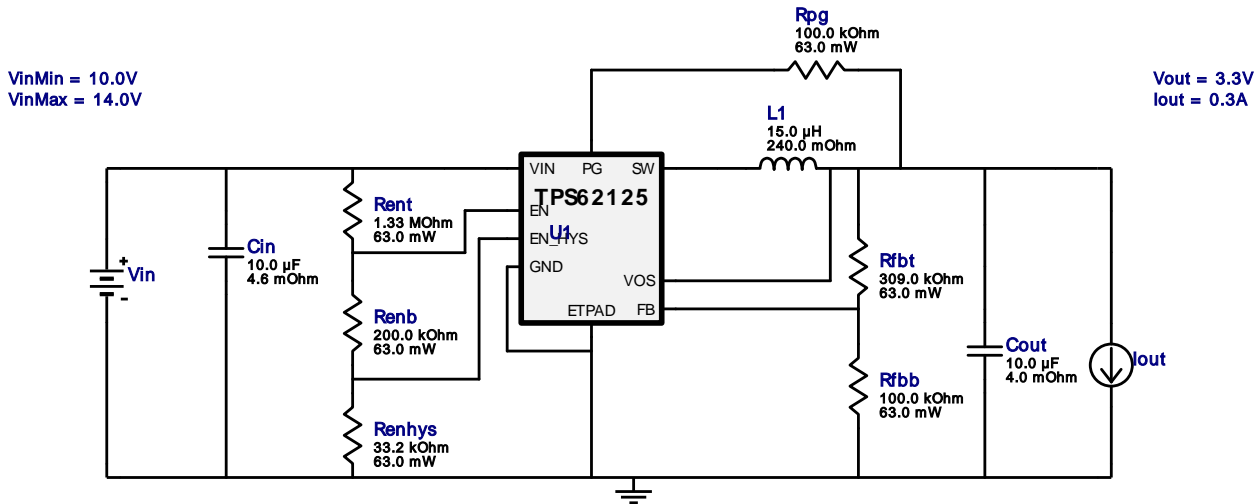

Electrical BOM

#	Name	Manufacturer	Part Number	Properties	Qty	Price	Footprint
1.	Cin	TDK	C3216X5R1C106KT Series= X5R	Cap= 10.0 uF ESR= 4.6 mOhm VDC= 16.0 V IRMS= 2.7 A	1	\$0.08	1206 11 mm ²
2.	Cout	Kemet	C0603C106M9PACTU Series= X5R	Cap= 10.0 uF ESR= 4.0 mOhm VDC= 6.3 V IRMS= 8.9 A	1	\$0.08	0603 5 mm ²
3.	L1	Bourns	SDR0403-150ML	L= 15.0 uH DCR= 240.0 mOhm	1	\$0.18	SDR0403 28 mm ²
4.	Renb	Vishay-Dale	CRCW0402200KFKED Series= CRCW..e3	Res= 200.0 kOhm Power= 63.0 mW Tolerance= 1.0%	1	\$0.01	0402 3 mm ²
5.	Renhys	Vishay-Dale	CRCW040233K2FKED Series= CRCW..e3	Res= 33.2 kOhm Power= 63.0 mW Tolerance= 1.0%	1	\$0.01	0402 3 mm ²
6.	Rent	Vishay-Dale	CRCW04021M33FKED Series= CRCW..e3	Res= 1.33 MOhm Power= 63.0 mW Tolerance= 1.0%	1	\$0.01	0402 3 mm ²
7.	Rfbb	Vishay-Dale	CRCW0402100KFKED Series= CRCW..e3	Res= 100.0 kOhm Power= 63.0 mW Tolerance= 1.0%	1	\$0.01	0402 3 mm ²
8.	Rfbt	Vishay-Dale	CRCW0402309KFKED Series= CRCW..e3	Res= 309.0 kOhm Power= 63.0 mW Tolerance= 1.0%	1	\$0.01	0402 3 mm ²
9.	Rpg	Vishay-Dale	CRCW0402100KFKED Series= CRCW..e3	Res= 100.0 kOhm Power= 63.0 mW Tolerance= 1.0%	1	\$0.01	0402 3 mm ²

#	Name	Manufacturer	Part Number	Properties	Qty	Price	Footprint
10.	U1	Texas Instruments	TPS62125DSGR	Switcher	1	\$0.61	 S-PWSON-N8 10 mm ²

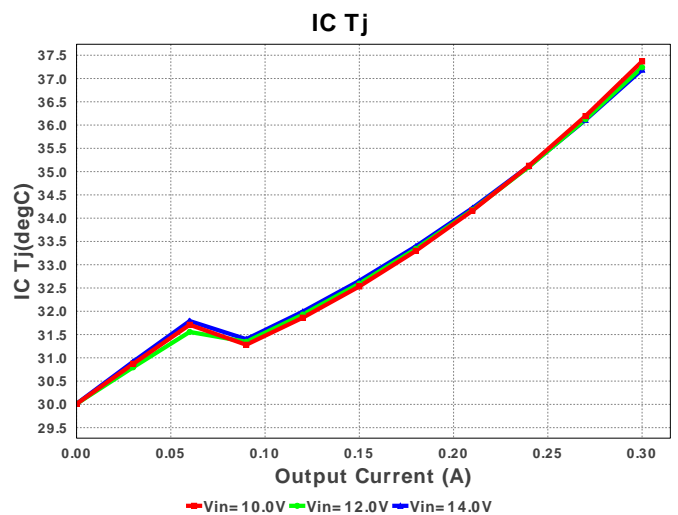
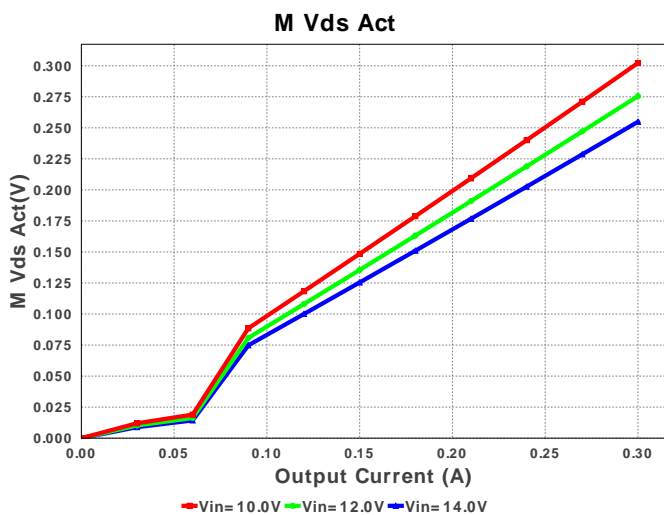
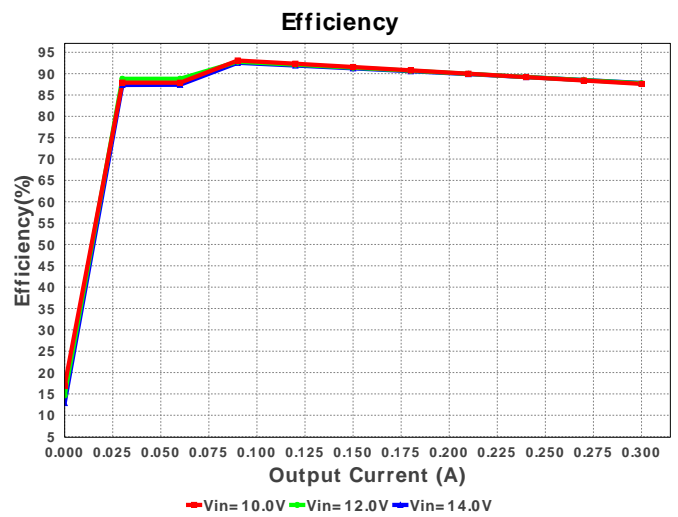
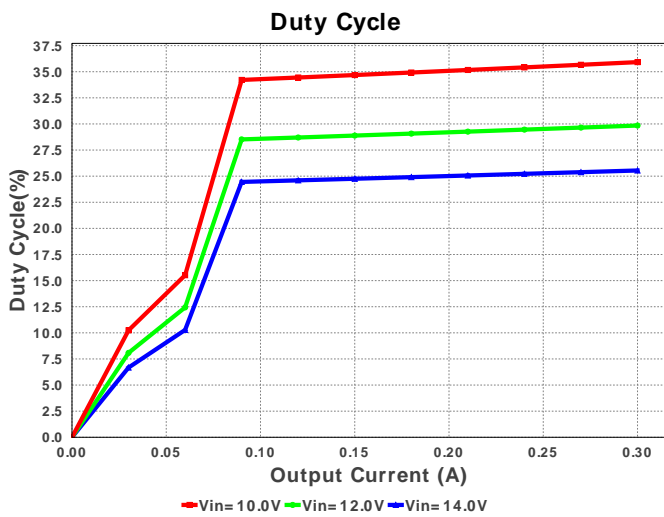
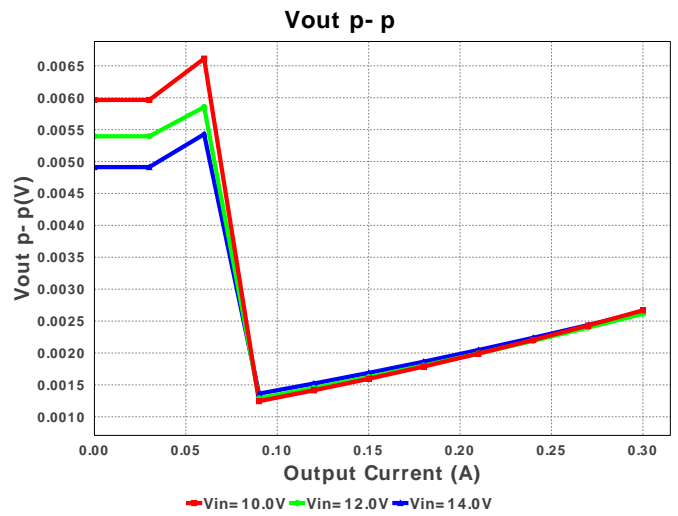
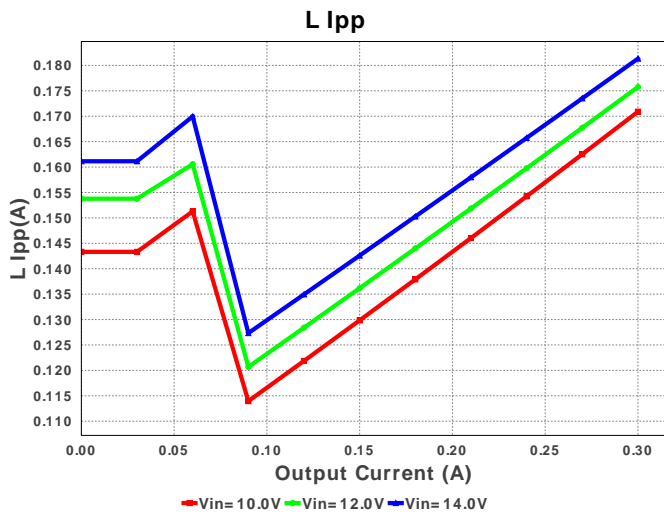

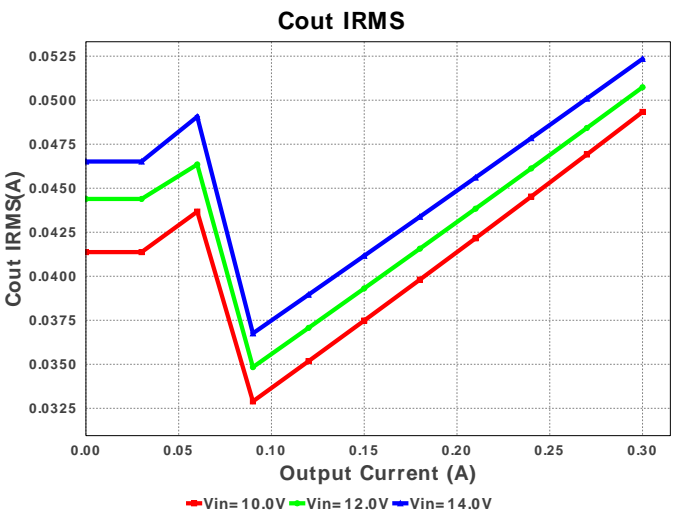
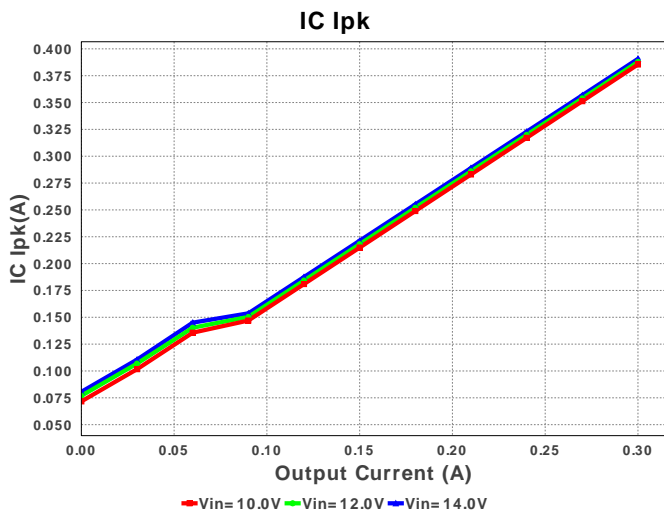
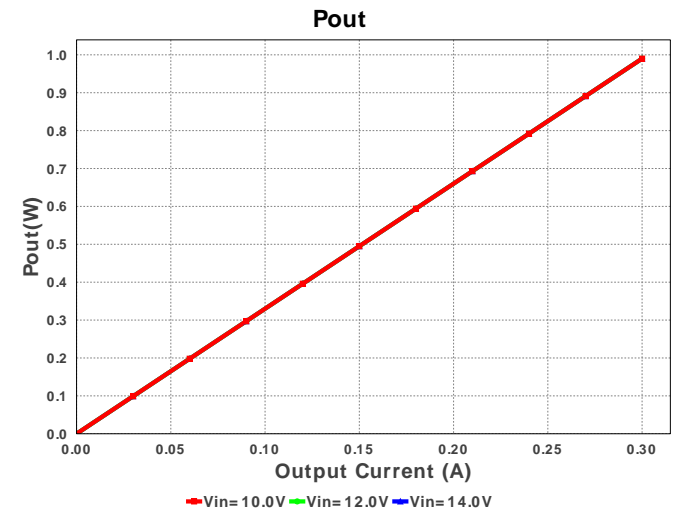
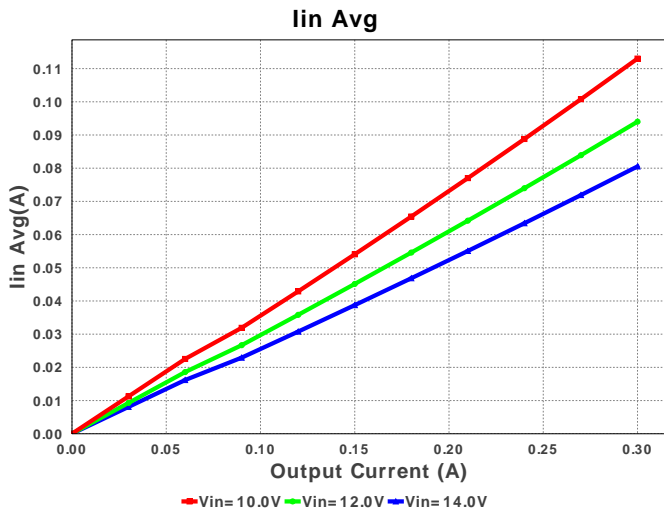
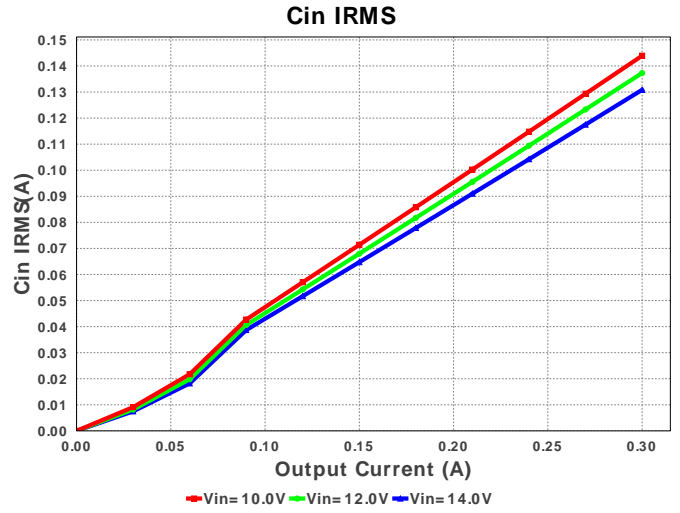
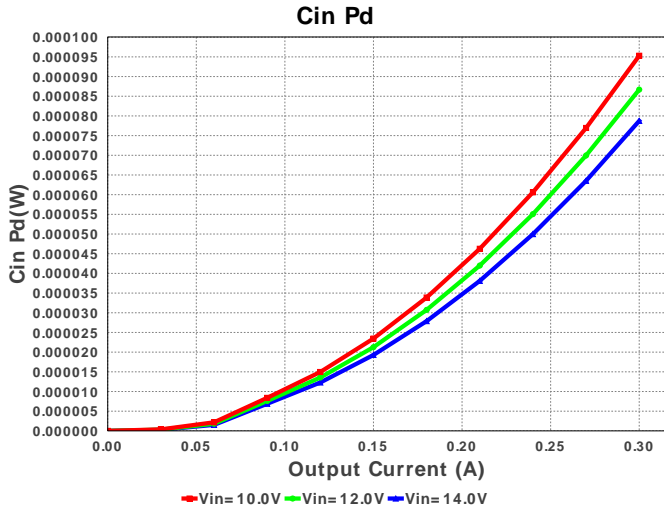

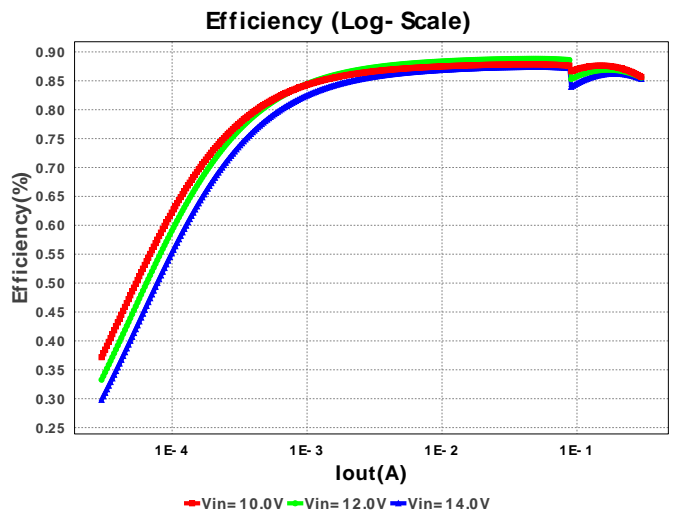
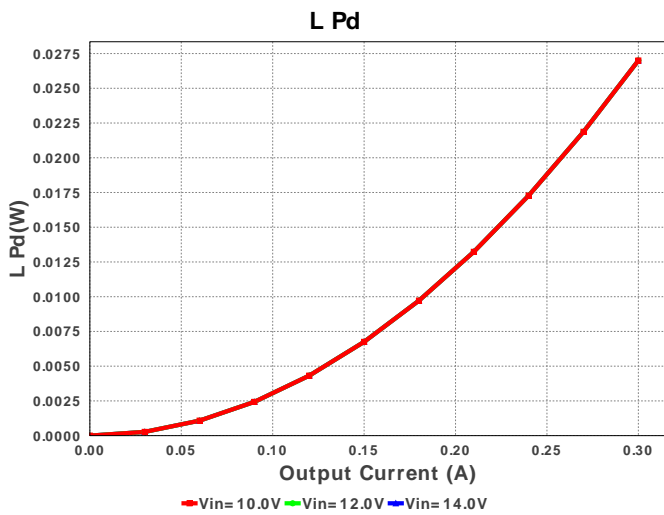
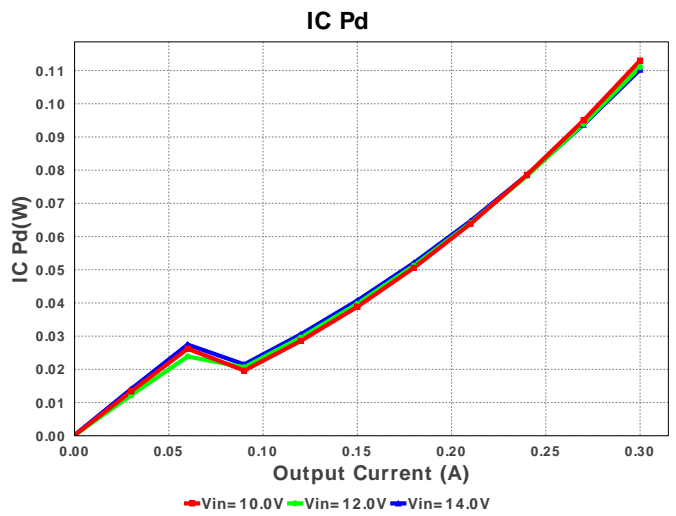
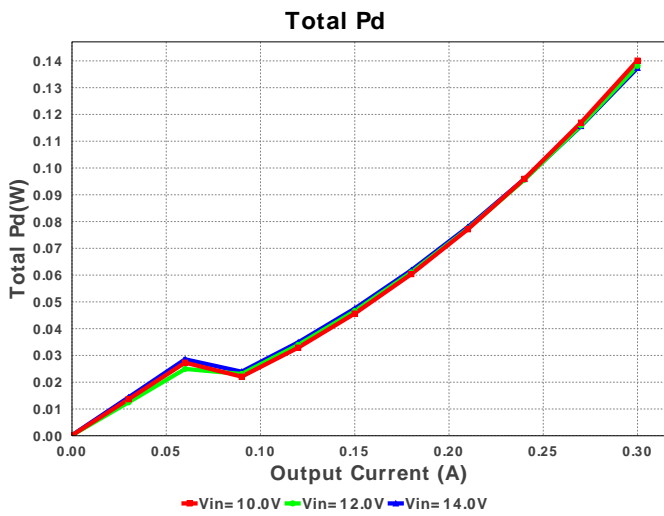
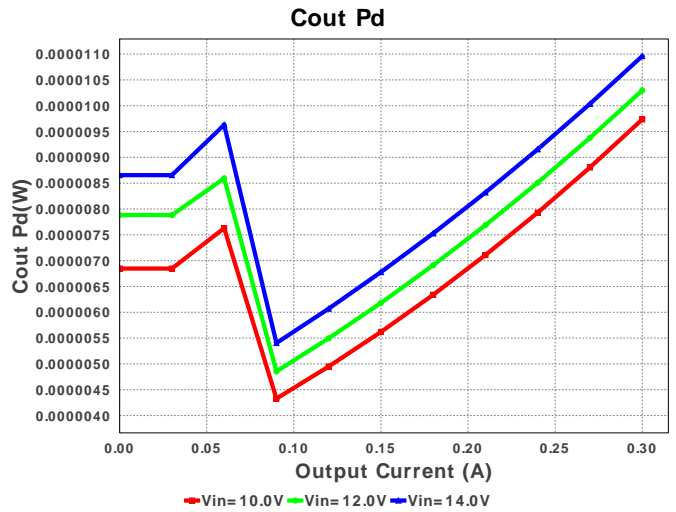
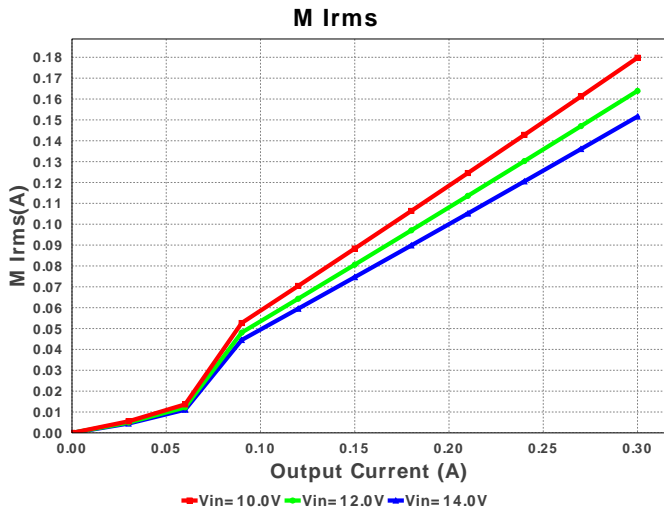

Operating Values

#	Name	Value	Category	Description
1.	Cin IRMS	130.832 mA	Current	Input capacitor RMS ripple current
2.	Cout IRMS	52.347 mA	Current	Output capacitor RMS ripple current
3.	IC Ipk	390.668 mA	Current	Peak switch current in IC
4.	Iin Avg	80.527 mA	Current	Average input current
5.	L Ipp	181.34 mA	Current	Peak-to-peak inductor ripple current
6.	M Irms	151.622 mA	Current	MOSFET RMS current
7.	BOM Count	10	General	Total Design BOM count
8.	FootPrint	71.0 mm ²	General	Total Foot Print Area of BOM components
9.	Frequency	1.005 MHz	General	Switching frequency
10.	IC Tolerance	25.0 mV	General	IC Feedback Tolerance
11.	M Vds Act	254.848 mV	General	Voltage drop across the MosFET

#	Name	Value	Category	Description
12.	Pout	990.0 mW	General	Total output power
13.	Total BOM	\$1.01	General	Total BOM Cost
14.	Vout OP	3.3 V	Op_Point	Operational Output Voltage
15.	Duty Cycle	25.544 %	Op_point	Duty cycle
16.	Efficiency	87.815 %	Op_point	Steady state efficiency
17.	IC Tj	37.19 degC	Op_point	IC junction temperature
18.	ICThetaJA	65.2 degC/W	Op_point	IC junction-to-ambient thermal resistance
19.	IOUT_OP	300.0 mA	Op_point	Iout operating point
20.	VIN_OP	14.0 V	Op_point	Vin operating point
21.	Vout p-p	2.645 mV	Op_point	Peak-to-peak output ripple voltage
22.	Cin Pd	78.738 μ W	Power	Input capacitor power dissipation
23.	Cout Pd	10.961 μ W	Power	Output capacitor power dissipation
24.	IC Pd	110.283 mW	Power	IC power dissipation
25.	L Pd	27.0 mW	Power	Inductor power dissipation
26.	Total Pd	137.371 mW	Power	Total Power Dissipation

Design Inputs

#	Name	Value	Description
1.	Iout	300.0 m	Maximum Output Current
2.	Iout1	300.0 m	Output Current #1
3.	SoftStart	1.0 ms	Soft Start Time (ms)
4.	VinMax	14.0	Maximum input voltage
5.	VinMin	10.0	Minimum input voltage
6.	Vout	3.3	Output Voltage
7.	Vout1	3.3	Output Voltage #1
8.	base_pn	TPS62125	Texas Instruments Base Part Number
9.	source	DC	Input Source Type
10.	ta	30.0	Ambient temperature

Design Assistance

1. TPS62125 Product Folder : <http://www.ti.com/product/TPS62125> : contains the data sheet and other resources.

Texas Instruments' WEBENCH simulation tools attempt to recreate the performance of a substantially equivalent physical implementation of the design. Simulations are created using Texas Instruments' published specifications as well as the published specifications of other device manufacturers. While Texas Instruments does update this information periodically, this information may not be current at the time the simulation is built. Texas Instruments does not warrant the accuracy or completeness of the specifications or any information contained therein. Texas Instruments does not warrant that any designs or recommended parts will meet the specifications you entered, will be suitable for your application or fit for any particular purpose, or will operate as shown in the simulation in a physical implementation. Texas Instruments does not warrant that the designs are production worthy.

You should completely validate and test your design implementation to confirm the system functionality for your application prior to production.

Use of Texas Instruments' WEBENCH simulation tools is subject to [Texas Instruments' Site Terms and Conditions of Use](#). Prototype boards based on WEBENCH created designs are provided AS IS without warranty of any kind for evaluation and testing purposes and are subject to the terms of the [Evaluation License Agreement](#).