



50 MHz to 750 MHz CASCADEABLE AMPLIFIER

Check for Samples: [THS9000](#)

FEATURES

- **High Dynamic Range**
 - $OIP_3 = 36 \text{ dBm}$
 - $NF < 4.5 \text{ dB}$
- **Single-Supply Voltage**
- **High Speed**
 - $V_S = 3 \text{ V to } 5 \text{ V}$
 - $I_S = \text{Adjustable}$
- **Input/Output Impedance**
 - 50Ω

APPLICATIONS

- **IF Amplifiers**
 - **TDMA: GSM, IS-136, EDGE/UWE-136**
 - **CDMA: IS-95, UMTS, CDMA2000**
 - **Wireless Local Loops**
 - **Wireless LAN: IEEE802.11**

DESCRIPTION

The THS9000 is a medium power, cascadeable, gain block optimized for high IF frequencies. The amplifier incorporates internal impedance matching to 50Ω . The part mounted on the standard EVM achieves greater than 15-dB input and output return loss from 50 MHz to 325 MHz with $V_S = 5 \text{ V}$, $R_{(\text{BIAS})} = 237 \Omega$, $L_{(\text{COL})} = 470 \text{ nH}$. Design requires only two dc-blocking capacitors, one power-supply bypass capacitor, one RF choke, and one bias resistor.

Figure 1. FUNCTIONAL BLOCK DIAGRAM

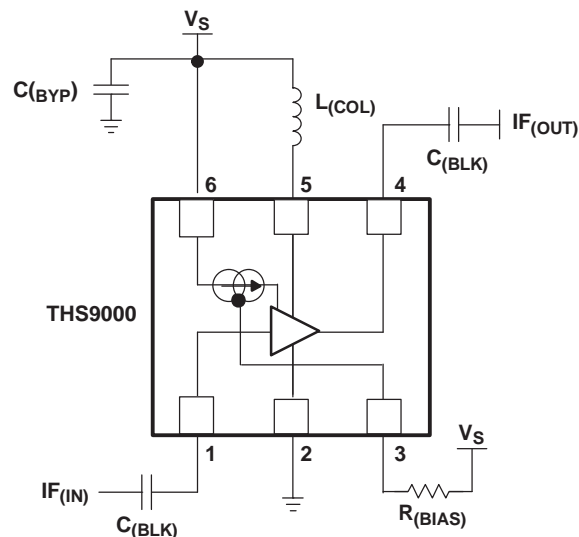

Please be aware that an important notice concerning availability, standard warranty, and use in critical applications of Texas Instruments semiconductor products and disclaimers thereto appears at the end of this data sheet.

PowerPAD is a trademark of Texas Instruments Incorporated.
All other trademarks are the property of their respective owners.



These devices have limited built-in ESD protection. The leads should be shorted together or the device placed in conductive foam during storage or handling to prevent electrostatic damage to the MOS gates.

AVAILABLE OPTIONS

PACKAGED DEVICE ⁽¹⁾	PACKAGE TYPE	TRANSPORT MEDIA, QUANTITY
THS9000DRWT	2 × 2 QFN ⁽²⁾	Tape and Reel, 250
THS9000DRWR		Tape and Reel, 3000

- (1) For the most current package and ordering information, see the Package Option Addendum at the end of this document, or see the TI Web site at www.ti.com.
- (2) The PowerPAD™ is electrically isolated from all other pins.

ABSOLUTE MAXIMUM RATINGS

Over operating free-air temperature (unless otherwise noted)⁽¹⁾

	THS9000	UNIT	
Supply voltage, GND to V _S	5.5	V	
Input voltage	GND to V _S		
Continuous power dissipation	See Dissipation Rating table		
Maximum junction temperature, T _J	+150	°C	
Maximum junction temperature, continuous operation, long term reliability, T _J ⁽²⁾	+125	°C	
Storage temperature, T _{stg}	–65 to +150	°C	
Lead temperature 1,6 mm (1/16 inch) from case for 10 seconds	+300	°C	
ESD Ratings:	HBM	2000	V
	CDM	1500	V
	MM	100	V

- (1) The absolute maximum ratings under any condition is limited by the constraints of the silicon process. Stresses above these ratings may cause permanent damage. Exposure to absolute maximum conditions for extended periods may degrade device reliability. These are stress ratings only, and functional operation of the device at these or any other conditions beyond those specified is not implied.
- (2) The maximum junction temperature for continuous operation is limited by package constraints. Operation above this temperature may result in reduced reliability and/or lifetime of the device.

DISSIPATION RATING TABLE

PACKAGE	θ_{JA} (°C/W)	POWER RATING ⁽¹⁾	
		T _A ≤ +25°C	T _A = +85°C
DRW ^{(2) (3)}	91	1.1 W	440 mW

- (1) Power rating is determined with a junction temperature of +125°C. Thermal management of the final PCB should strive to keep the junction temperature at or below +125°C for best performance.
- (2) This data was taken using the JEDEC standard High-K test PCB.
- (3) The THS9000 incorporates a PowerPAD on the underside of the chip. This acts as a heatsink and must be connected to a thermally dissipating plane for proper power dissipation. Failure to do so may result in exceeding the maximum junction temperature, which could permanently damage the device. See TI Technical Brief [SLMA002](#) for more information about utilizing the PowerPAD thermally-enhanced package.

RECOMMENDED OPERATING CONDITIONS

	MIN	NOM	MAX	UNIT
Supply voltage	2.7		5	V
Operating free-air temperature, T _A	–40		+85	°C
Supply current		100		mA

ELECTRICAL CHARACTERISTICS

 Typical Performance ($V_S = 5\text{ V}$, $R_{\text{BIAS}} = 237\ \Omega$, $L_{\text{(COL)}} = 470\ \text{nH}$) (unless otherwise noted)

PARAMETER	TEST CONDITIONS	MIN	TYP	MAX	UNITS
Gain	$f = 50\ \text{MHz}$		15.9		dB
	$f = 350\ \text{MHz}$		15.6		
OIP ₃	$f = 50\ \text{MHz}$		36		dBm
	$f = 350\ \text{MHz}$		35		
1-dB compression	$f = 50\ \text{MHz}$		20.8		dBm
	$f = 350\ \text{MHz}$		20.6		
Input return loss	$f = 50\ \text{MHz}$		15		dB
	$f = 350\ \text{MHz}$		19.7		
Output return loss	$f = 50\ \text{MHz}$		17.2		dB
	$f = 350\ \text{MHz}$		15.1		
Reverse isolation	$f = 50\ \text{MHz}$		21		dB
	$f = 350\ \text{MHz}$		20		
Noise figure	$f = 50\ \text{MHz}$		3.6		dB
	$f = 350\ \text{MHz}$		4		

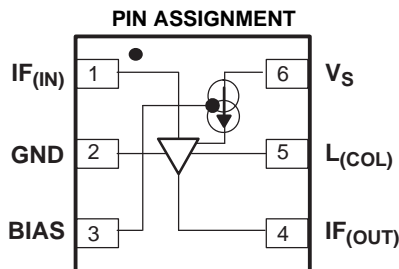

Terminal Functions

PIN NUMBERS	NAME	DESCRIPTION
1	IF _(IN)	Signal input
2	GND	Negative power-supply input
3	BIAS	Bias current adjustment input
4	IF _(OUT)	Signal output
5	L _(COL)	Output transistor load inductor
6	V _S	Positive power-supply input

SIMPLIFIED SCHEMATIC

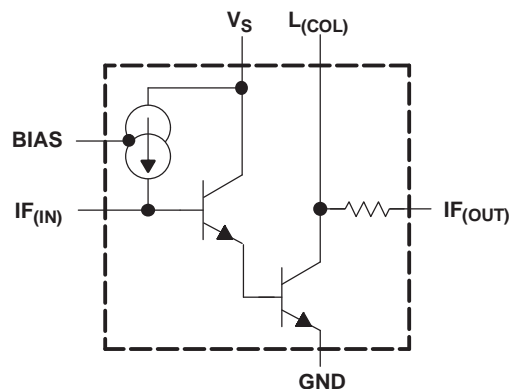

TABLE OF GRAPHS

	FIGURE
S21 Frequency response	1
S22 Frequency response	2
S11 Frequency response	3
S12 Frequency response	4
S21 vs $R_{(Bias)}$	5
Output power vs Input power	6
OIP ₂ vs Frequency	7
Noise figure vs Frequency	8
OIP ₃ vs Frequency	9
I_S Supply current vs $R_{(Bias)}$	10
S21 Frequency response	11
S22 Frequency response	12
S11 Frequency response	13
S12 Frequency response	14
Noise figure vs Frequency	15
OIP ₂ vs Frequency	16
Output power vs Input power	17
OIP ₃ vs Frequency	18

TYPICAL CHARACTERISTICS

S-Parameters of THS9000 as mounted on the EVM with $V_S = 5\text{ V}$, $R_{(BIAS)} = 237\ \Omega$, and $L_{(COL)} = 68\text{ nH}$ to 470 nH at room temperature.

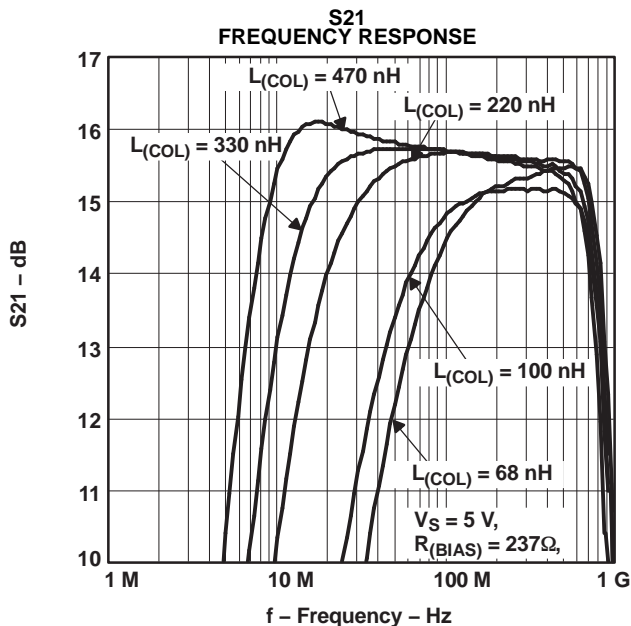

Figure 2.

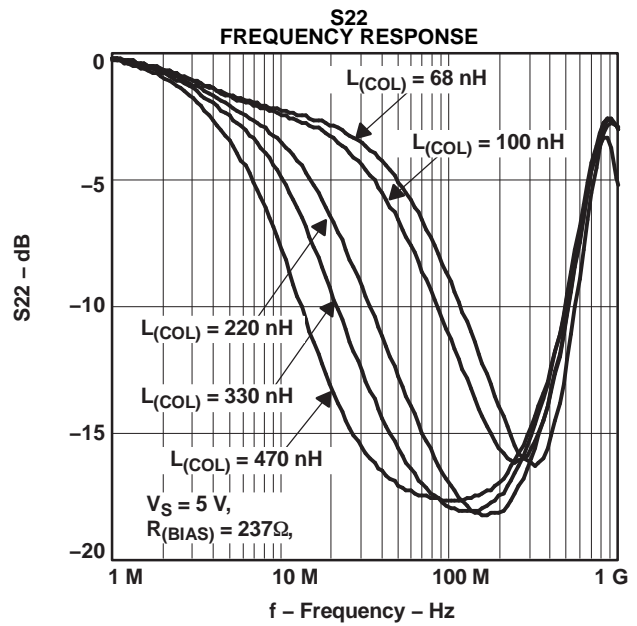

Figure 3.

TYPICAL CHARACTERISTICS (continued)

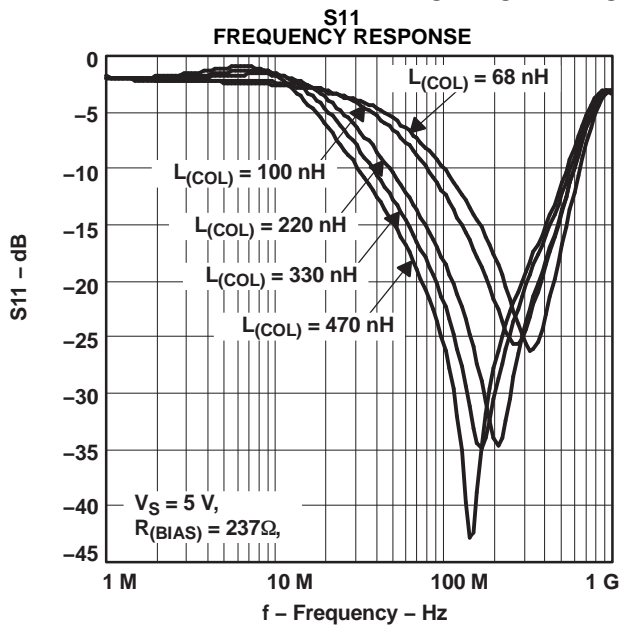

Figure 4.

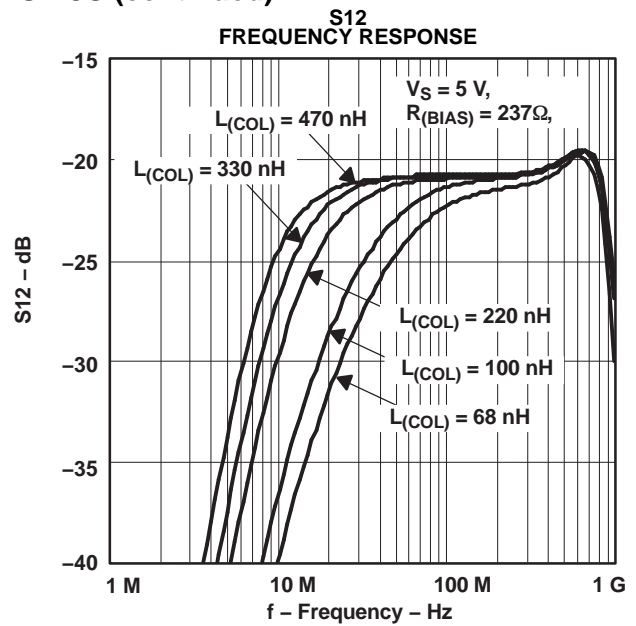

Figure 5.

S-Parameters of THS9000 as mounted on the EVM with $V_S = 3 \text{ V}$ and 5 V , $R_{(BIAS)} = \text{various}$, and $L_{(COL)} = 470 \text{ nH}$ at room temp.

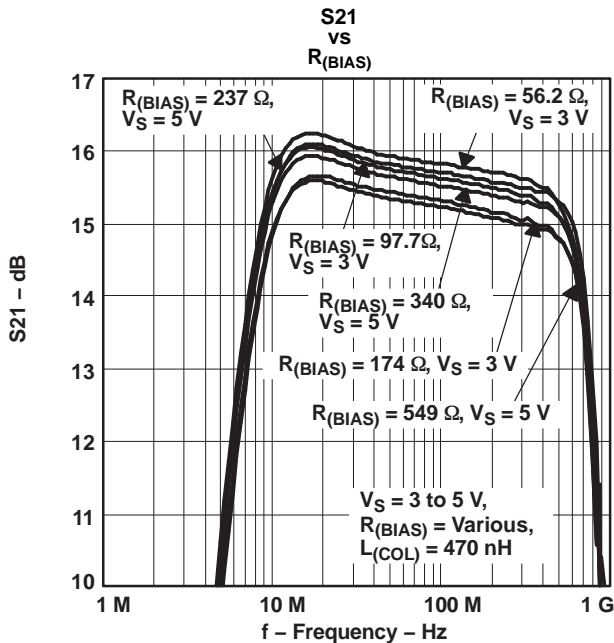

Figure 6.

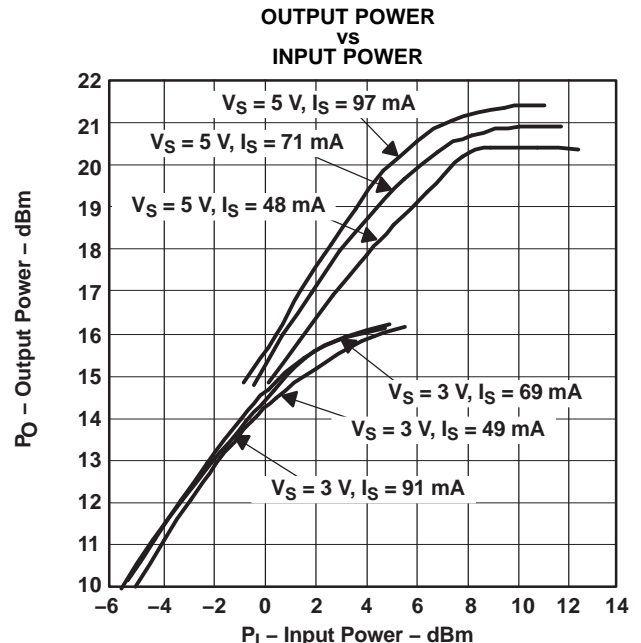

Figure 7.

TYPICAL CHARACTERISTICS (continued)

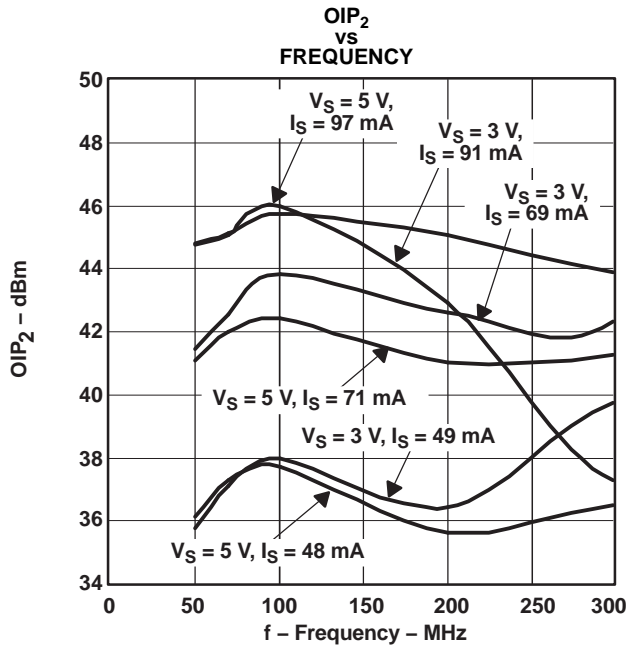

Figure 8.

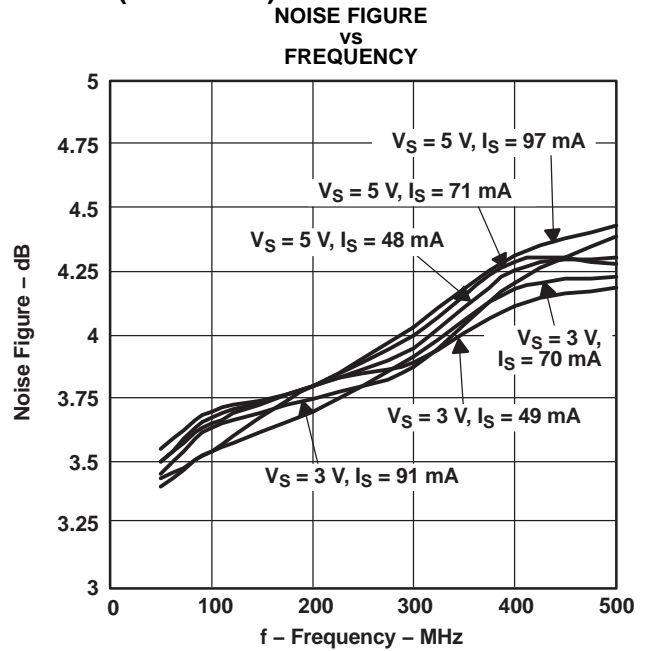

Figure 9.

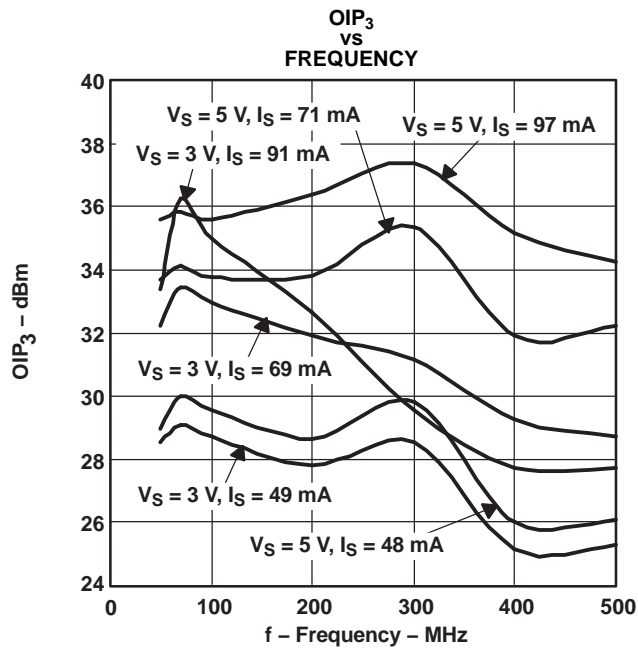

Figure 10.

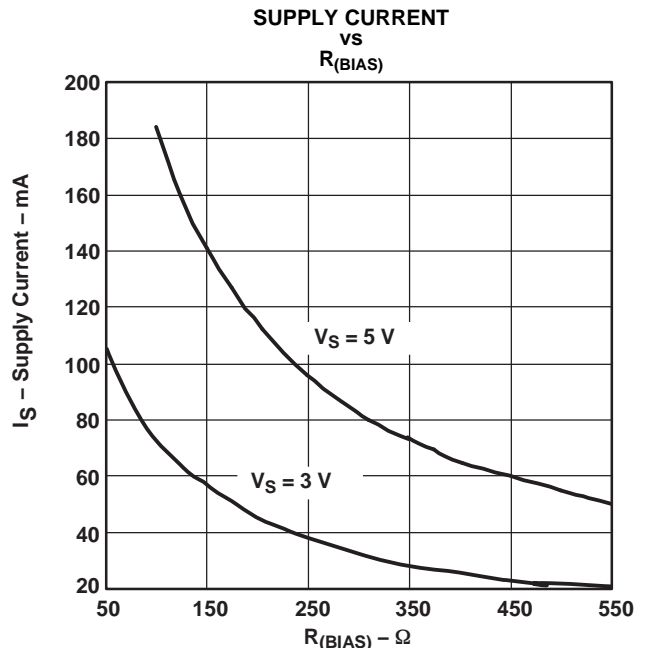

Figure 11.

TYPICAL CHARACTERISTICS (continued)

THS9000 as mounted on the EVM with $V_S = 5\text{ V}$, $R_{(BIAS)} = 237\ \Omega$, and $L_{(COL)} = 470\text{ nH}$ at $+40^\circ\text{C}$, $+25^\circ\text{C}$, and $+85^\circ\text{C}$.

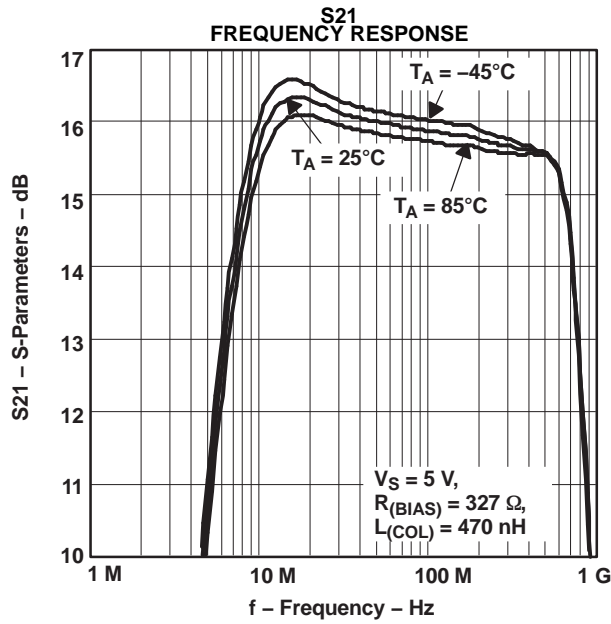

Figure 12.

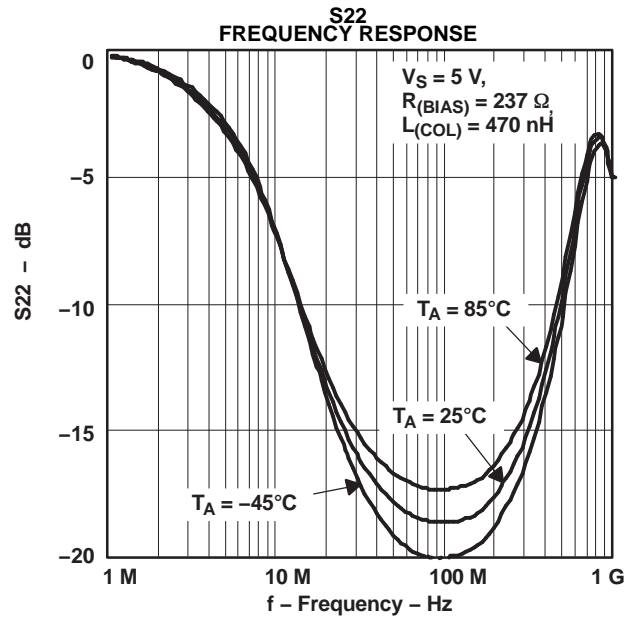

Figure 13.

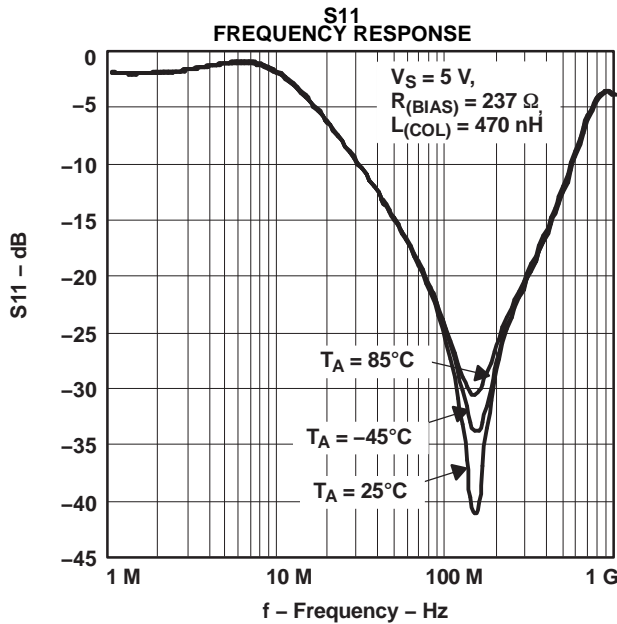

Figure 14.

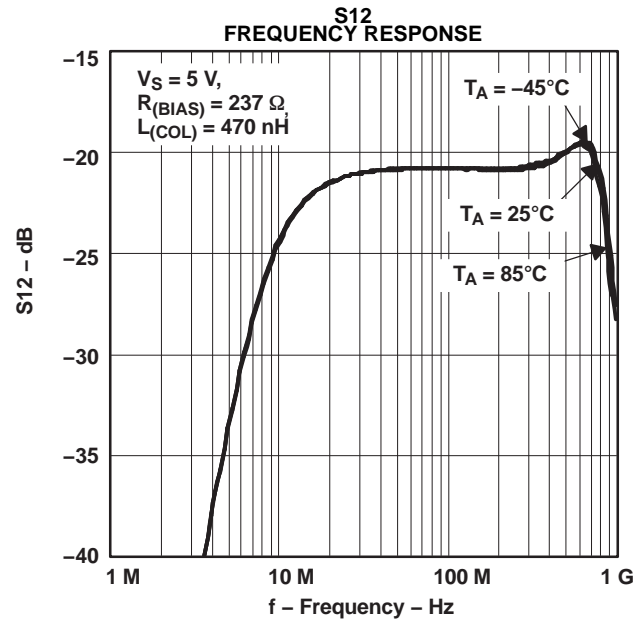

Figure 15.

TYPICAL CHARACTERISTICS (continued)

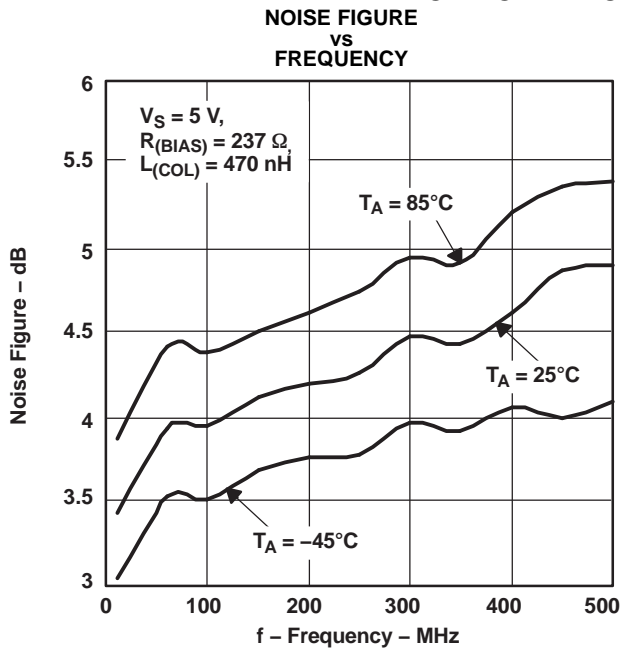

Figure 16.

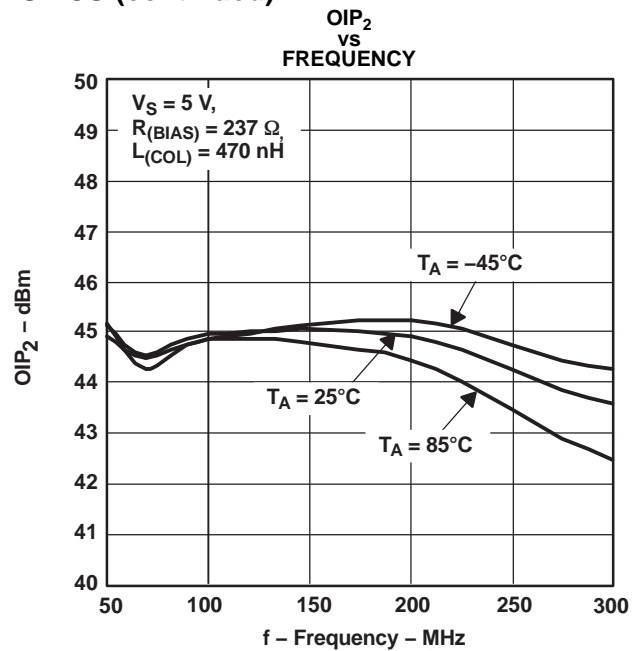

Figure 17.

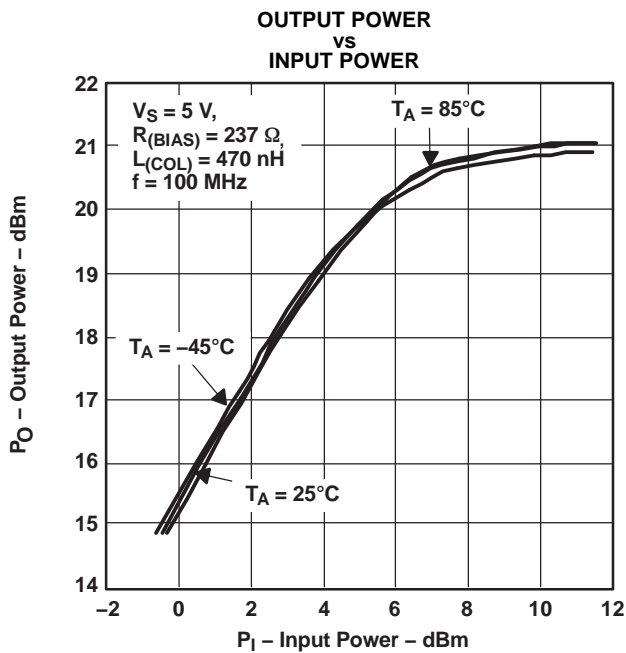

Figure 18.

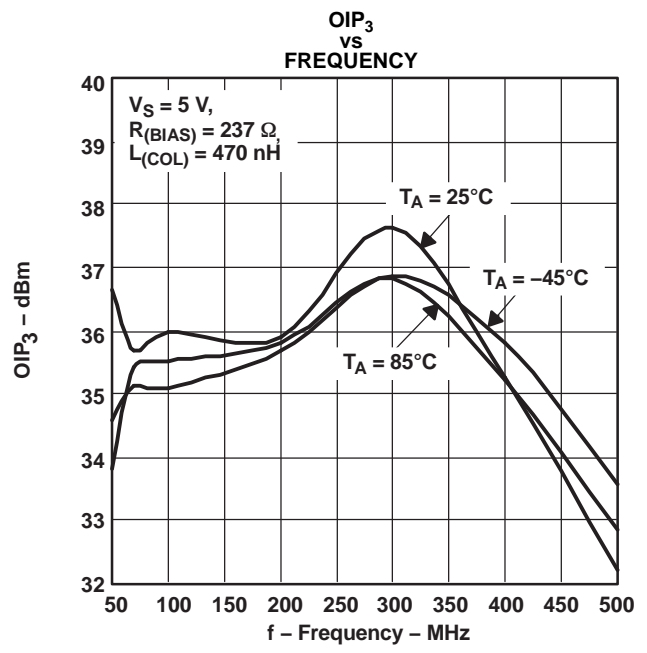

Figure 19.

TYPICAL CHARACTERISTICS

Table 1. S-Parameters Tables of THS9000 with EVM De-Embedded

$V_S = 5\text{ V}$, $R_{(\text{BIAS})} = 237\ \Omega$, $L_{(\text{COL})} = 470\ \text{nH}$								
FREQUENCY (MHz)	S21		S11		S22		S12	
	GAIN (dB)	PHASE (°)	GAIN (dB)	PHASE (°)	GAIN (dB)	PHASE (°)	GAIN (dB)	PHASE (°)
1.0	-4.2	-169.5	-2.4	-0.9	-1.9	158.1	-63.1	167.0
5.0	11.3	-124.5	-1.5	-14.5	-2.6	138.0	-32.9	122.4
10.2	15.8	-147.8	-2.2	-42.3	-5.0	101.0	-24.0	80.4
19.7	16.4	-169.4	-6.5	-69.7	-10.5	66.6	-21.3	41.6
50.1	16.0	177.2	-15.6	-91.4	-16.7	30.1	-20.7	14.4
69.7	15.9	173.5	-19.8	-97.7	-17.8	17.7	-20.7	9.1
102.4	15.9	168.4	-26.9	-102.6	-18.2	4.3	-20.7	4.4
150.5	15.8	162.0	-39.0	14.1	-18.1	-8.6	-20.7	-0.7
198.1	15.7	155.8	-27.6	50.8	-17.4	-19.6	-20.7	-1.7
246.9	15.7	149.6	-23.7	40.6	-16.4	-26.7	-20.7	-3.5
307.6	15.6	141.9	-19.8	33.1	-14.9	-37.2	-20.6	-5.7
362.8	15.6	134.7	-17.3	24.7	-13.3	-44.3	-20.4	-7.7
405.0	15.6	129.2	-15.5	20.3	-12.1	-51.0	-20.2	-10.0
452.2	15.6	122.3	-13.8	14.7	-10.6	-58.1	-19.9	-12.5
504.7	15.5	114.9	-11.8	6.3	-9.0	-66.5	-19.7	-16.2
563.4	15.4	105.8	-9.7	-2.9	-7.2	-77.5	-19.4	-22.4
595.3	15.3	100.5	-8.6	-9.1	-6.3	-83.6	-19.3	-26.2
664.5	14.9	88.7	-6.3	-24.2	-4.4	-99.7	-19.3	-36.7
702.1	14.6	81.0	-5.3	-33.2	-3.7	-109.2	-19.6	-43.4
741.8	14.1	76.3	-4.4	-42.9	-3.0	-118.8	-19.9	-50.2
828.1	12.7	60.2	-2.9	-65.5	-2.3	-142.8	-21.7	-69.2
874.9	11.2	51.0	-2.5	-77.9	-2.5	-155.0	-23.6	-75.0
924.4	10.1	50.2	-2.4	-90.4	-3.1	-166.0	-25.8	-85.2
976.7	8.8	51.8	-2.5	-100.7	-4.3	-173.7	-28.4	-78.9
1031.9	9.2	58.2	-2.6	-108.7	-4.7	-175.2	-29.7	-68.7
1090.3	8.9	48.0	-2.5	-115.2	-4.4	-164.7	-31.4	-69.1
1151.9	8.8	39.9	-2.3	-123.3	-3.5	-175.4	-33.6	-83.4
1217.1	8.0	27.7	-2.1	-132.0	-3.0	175.3	-38.2	-81.4
1285.9	7.0	30.5	-2.0	-140.7	-2.8	168.7	-42.3	-25.5
1358.6	5.6	20.6	-1.9	-149.4	-2.9	159.1	-42.2	41.6
1435.5	4.3	19.5	-1.8	-159.4	-3.0	151.3	-38.7	63.3
1516.6	3.4	17.7	-1.9	-168.3	-3.2	144.7	-33.6	62.4
1602.4	2.8	16.5	-2.0	-177.2	-3.5	138.2	-30.5	59.6
1693.0	2.2	8.6	-2.1	174.0	-3.8	131.4	-28.1	56.2
1788.8	1.4	-0.7	-2.2	165.4	-4.1	124.6	-26.2	50.4
1889.9	0.5	-4.1	-2.3	157.0	-4.5	118.2	-24.7	42.4
1996.8	-0.6	-4.5	-2.6	150.0	-4.9	111.2	-24.2	39.5

APPLICATION INFORMATION

The THS9000 is a medium power, cascadeable, amplifier optimized for high intermediate frequencies in radios. The amplifier is unconditionally stable and the design requires only two dc-blocking capacitors, one power-supply bypass capacitor, one RF choke, and one bias resistor. Refer to [Figure 26](#) for the circuit diagram.

The THS9000 operates with a power-supply voltage ranging from 2.5 V to 5.5 V.

The value of $R_{(BIAS)}$ sets the bias current to the amplifier. Refer to [Figure 11](#). This allows the designer to trade-off linearity versus power consumption. $R_{(BIAS)}$ can be removed without damage to the device.

Component selection of $C_{(BYP)}$, C_{IN} , and C_{OUT} is not critical. The values shown in [Figure 26](#) were used for all the data shown in this data sheet.

The amplifier incorporates internal impedance matching to $50\ \Omega$ that can be adjusted for various frequencies of operation by proper selection of $L_{(COL)}$.

[Figure 20](#) shows the s-parameters of the part mounted on the standard EVM with $V_S = 5\text{ V}$, $R_{(BIAS)} = 237\ \Omega$, and $L_{(COL)} = 470\text{ nH}$. With this configuration, the part is very broadband, and achieves greater than 15-dB input and output return loss from 50 MHz to 325 MHz.

[Figure 21](#) shows the S-parameters of the part mounted on the standard EVM with $V_S = 5\text{ V}$, $R_{(BIAS)} = 237\ \Omega$, and $L_{(COL)} = 68\text{ nH}$. With this configuration, the part achieves greater than 15-dB input and output return loss from 250 MHz to 400 MHz.

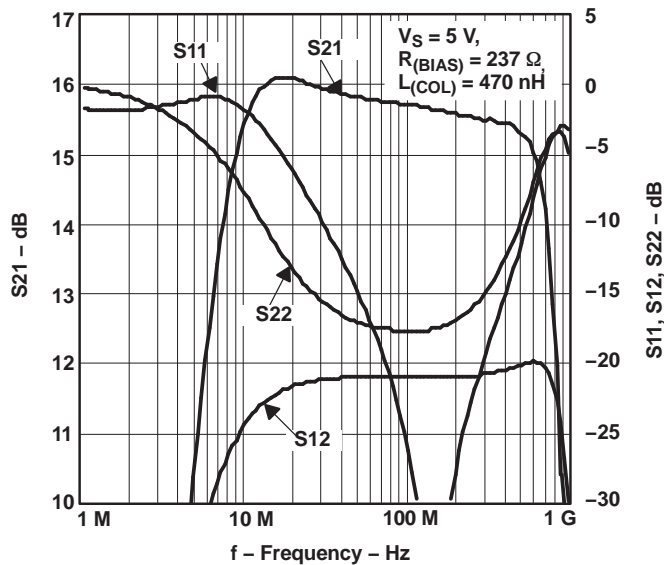

Figure 20. S-Parameters of THS9000 mounted on the standard EVM with $V_S = 5\text{ V}$, $R_{(BIAS)} = 237\ \Omega$, and $L_{(COL)} = 470\text{ nH}$

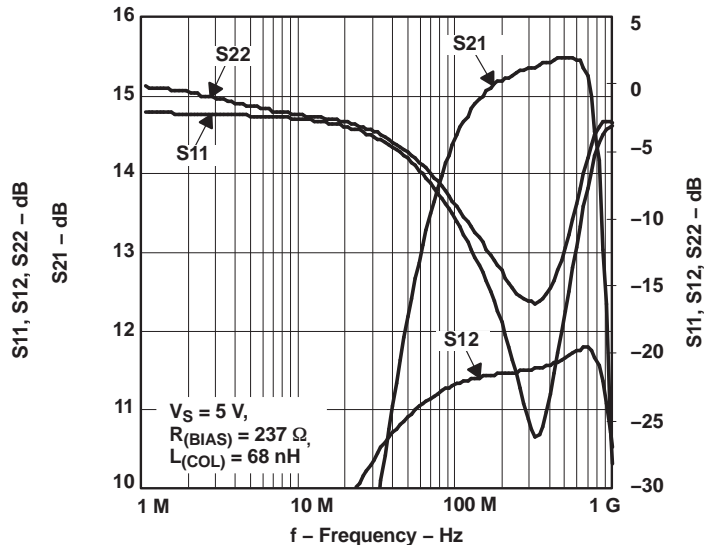

Figure 21. S-Parameters of THS9000 mounted on the standard EVM with $V_S = 5\text{ V}$, $R_{(BIAS)} = 237\ \Omega$, and $L_{(COL)} = 68\text{ nH}$

Figure 22 shows an example of a single conversion receiver architecture and where the THS9000 would typically be used.

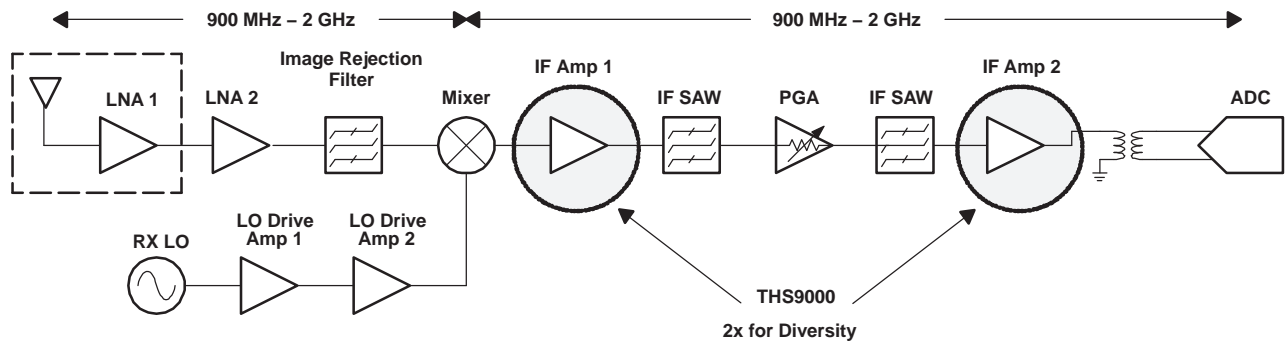

Figure 22. Example Single Conversion Receiver Architecture

Figure 23 shows an example of a dual conversion receiver architecture and where the THS9000 would typically be used.

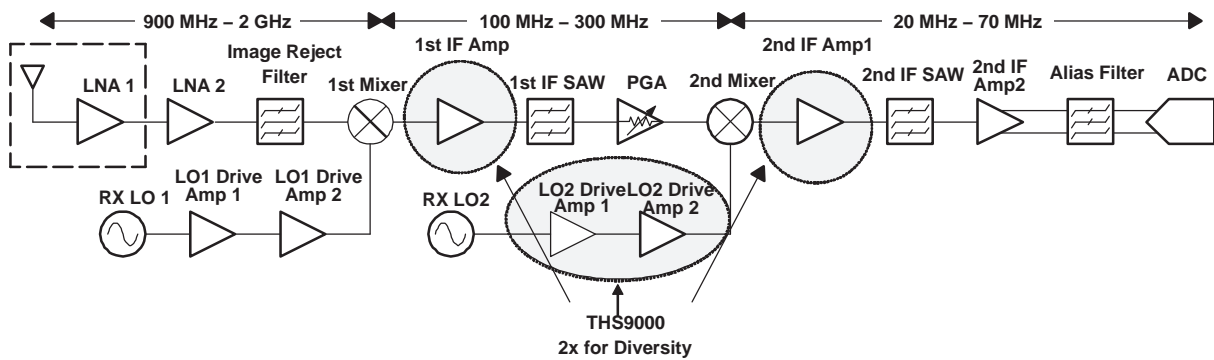

Figure 23. Example Dual Conversion Receiver Architecture

Figure 24 shows an example of a dual conversion transmitter architecture and where the THS9000 would typically be used.

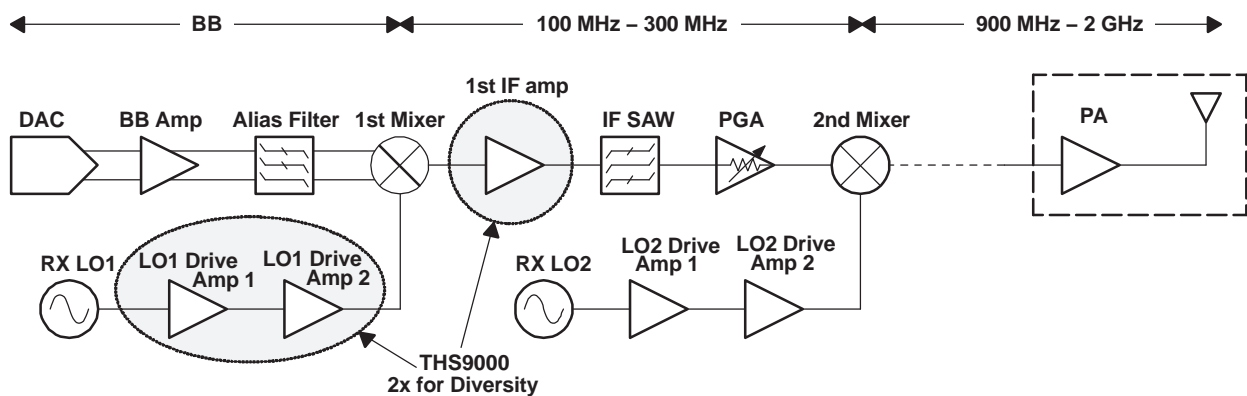

Figure 24. Example Dual Conversion Transmitter Architecture

Figure 25 shows the THS9000 and Sawtek #854916 SAW filter frequency response along with the frequency response of the SAW filter alone. The SAW filter has a center frequency of 140 MHz with 10-MHz bandwidth and 8-dB insertion loss. It can be seen that the frequency response with the THS9000 is the same as with the SAW except for a 15-dB gain. The THS9000 is mounted on the standard EVM with $V_S = 5\text{ V}$, $R_{(BIAS)} = 237\ \Omega$, and $L_{(COL)} = 470\text{ nH}$. Note the amplifier does not add artifacts to the signal.

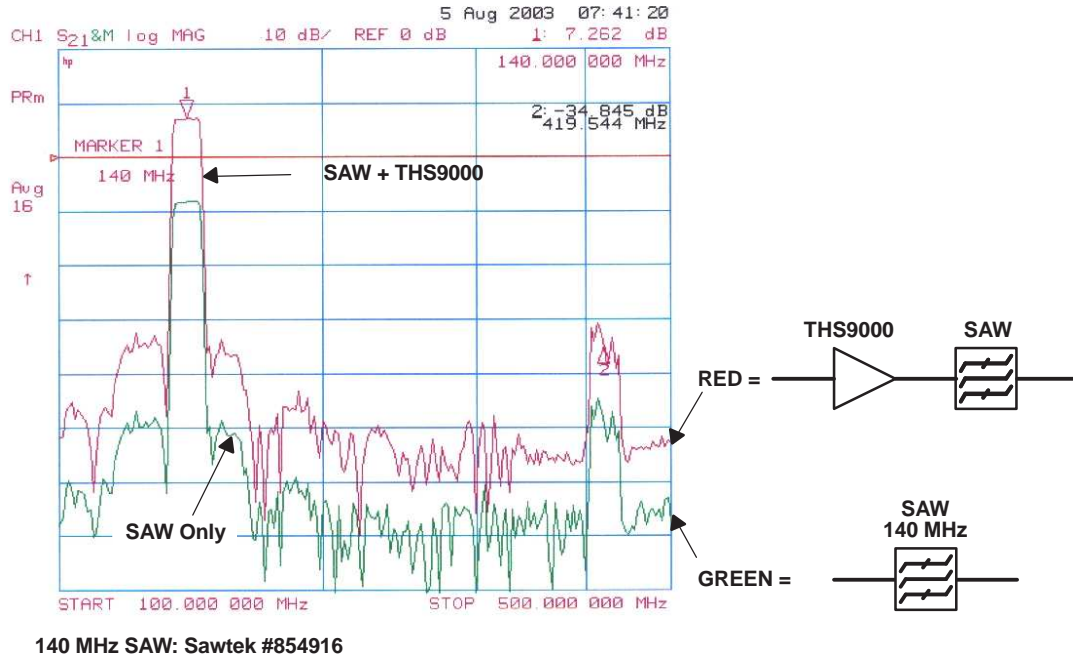

Figure 25. Frequency Response of the THS9000 and SAW Filter, and SAW Filter Only

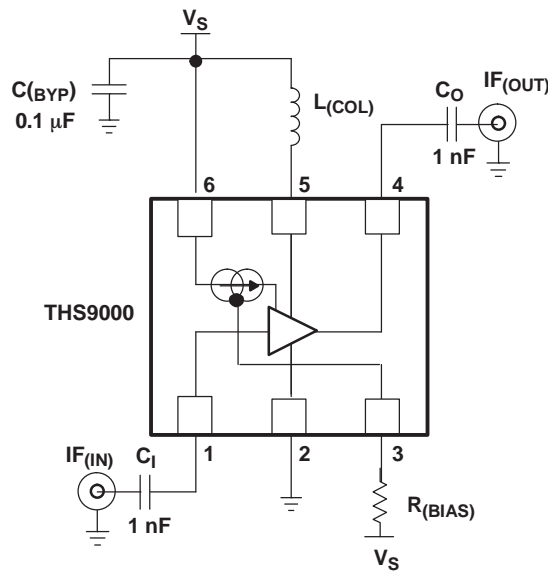

Figure 26. THS9000 Recommended Circuit (used for all tests)

Evaluation Module

Table 1 is the bill of materials, and [Figure 27](#) and [Figure 28](#) show the EVM layout.

Bill Of Materials

ITEM	DESCRIPTION	REF DES	QTY	PART NUMBER ⁽¹⁾
1	Cap, 0.1 μ F, ceramic, X7R, 50 V	C1	1	(AVX) 08055C104KAT2A
2	Cap, 1000 pF, ceramic, NPO, 100 V	C2, C3	2	(AVX) 08051A102JAT2A
3	Inductor, 470 nH, 5%	L1	1	(Coilcraft) 0805CS-471XJBC
4	Resistor, 237 Ω , 1/8 W, 1%	R1	1	(Phycomp) 9C08052A2370FKHFT
5	Open	TR1	1	
6	Jack, banana receptance, 0.25" dia.	J3, J4	2	(SPC) 813
7	Connector, edge, SMA PCB jack	J1, J2	2	(Johnson) 142-0701-801
8	Standoff, 4-40 Hex, 0.625" Length		4	(KEYSTONE) 1808
9	Screw, Phillips, 4-40, .250"		4	SHR-0440-016-SN
10	IC, THS9000	U1	1	(TI) THS9000DRD
11	Board, printed-circuit		1	(TI) EDGE # 6453521 Rev.A

(1) The manufacturer's part numbers are used for test purposes only.

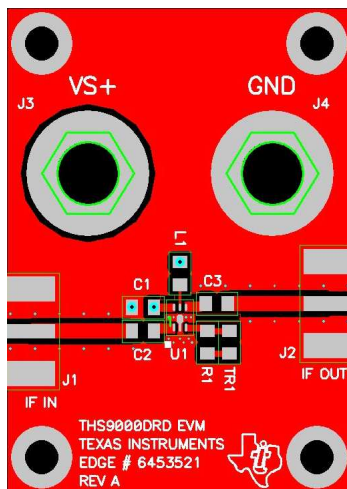

Figure 27. EVM Top Layout

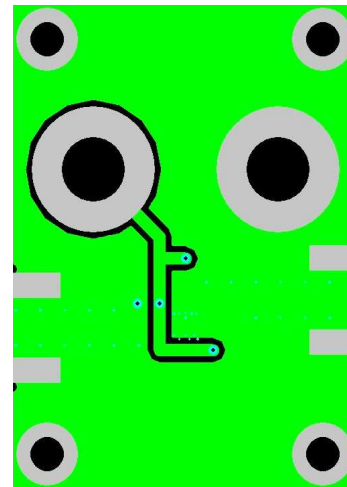

Figure 28. EVM Bottom Layout

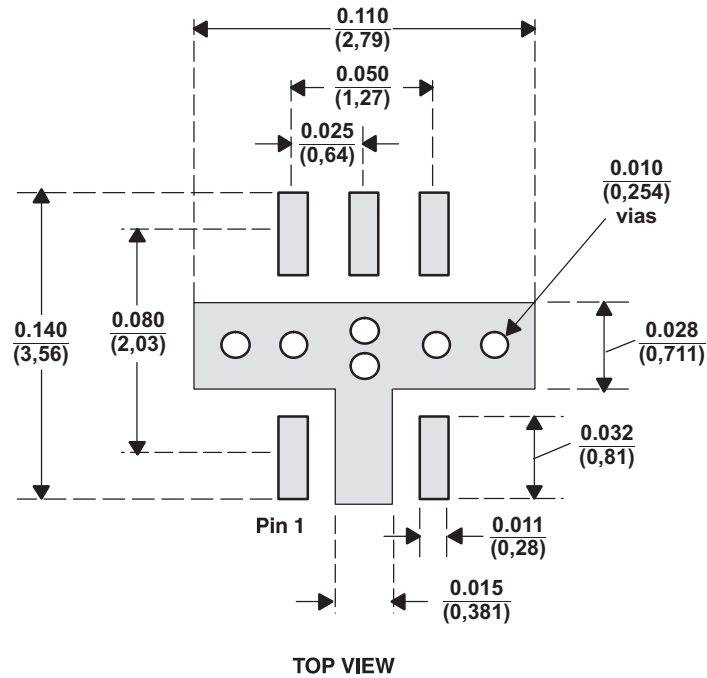

Figure 29. THS9000 Recommended Footprint dimensions are in inches (millimeters)

REVISION HISTORY

Changes from Revision D (October 2008) to Revision E	Page
---	-------------

- | | |
|--|---|
| <ul style="list-style-type: none"> • Changed the data sheet title From: 50 MHz to 400 MHz CASCADEABLE AMPLIFIER To: 50 MHz to 750 MHz CASCADEABLE AMPLIFIER | 1 |
|--|---|

Changes from Revision C (February 2007) to Revision D	Page
--	-------------

- | | |
|--|---|
| <ul style="list-style-type: none"> • Removed the DRD ordering options from the <i>Available Options</i> table | 2 |
| <ul style="list-style-type: none"> • Formatted the Absolute Maximum Ratings table to current standards | 2 |
| <ul style="list-style-type: none"> • Deleted DRD row from the <i>Dissipation Rating</i> table | 2 |

PACKAGING INFORMATION

Orderable Device	Status (1)	Package Type	Package Drawing	Pins	Package Qty	Eco Plan (2)	Lead/Ball Finish (6)	MSL Peak Temp (3)	Op Temp (°C)	Device Marking (4/5)	Samples
THS9000DRWR	ACTIVE	VSON	DRW	6	3000	Green (RoHS & no Sb/Br)	CU NIPDAUAG	Level-2-260C-1 YEAR	-40 to 85	BQX	Samples
THS9000DRWT	ACTIVE	VSON	DRW	6	250	Green (RoHS & no Sb/Br)	CU NIPDAUAG	Level-2-260C-1 YEAR	-40 to 85	BQX	Samples

(1) The marketing status values are defined as follows:

ACTIVE: Product device recommended for new designs.

LIFEBUY: TI has announced that the device will be discontinued, and a lifetime-buy period is in effect.

NRND: Not recommended for new designs. Device is in production to support existing customers, but TI does not recommend using this part in a new design.

PREVIEW: Device has been announced but is not in production. Samples may or may not be available.

OBSELETE: TI has discontinued the production of the device.

(2) Eco Plan - The planned eco-friendly classification: Pb-Free (RoHS), Pb-Free (RoHS Exempt), or Green (RoHS & no Sb/Br) - please check <http://www.ti.com/productcontent> for the latest availability information and additional product content details.

TBD: The Pb-Free/Green conversion plan has not been defined.

Pb-Free (RoHS): TI's terms "Lead-Free" or "Pb-Free" mean semiconductor products that are compatible with the current RoHS requirements for all 6 substances, including the requirement that lead not exceed 0.1% by weight in homogeneous materials. Where designed to be soldered at high temperatures, TI Pb-Free products are suitable for use in specified lead-free processes.

Pb-Free (RoHS Exempt): This component has a RoHS exemption for either 1) lead-based flip-chip solder bumps used between the die and package, or 2) lead-based die adhesive used between the die and leadframe. The component is otherwise considered Pb-Free (RoHS compatible) as defined above.

Green (RoHS & no Sb/Br): TI defines "Green" to mean Pb-Free (RoHS compatible), and free of Bromine (Br) and Antimony (Sb) based flame retardants (Br or Sb do not exceed 0.1% by weight in homogeneous material)

(3) MSL, Peak Temp. - The Moisture Sensitivity Level rating according to the JEDEC industry standard classifications, and peak solder temperature.

(4) There may be additional marking, which relates to the logo, the lot trace code information, or the environmental category on the device.

(5) Multiple Device Markings will be inside parentheses. Only one Device Marking contained in parentheses and separated by a "~" will appear on a device. If a line is indented then it is a continuation of the previous line and the two combined represent the entire Device Marking for that device.

(6) Lead/Ball Finish - Orderable Devices may have multiple material finish options. Finish options are separated by a vertical ruled line. Lead/Ball Finish values may wrap to two lines if the finish value exceeds the maximum column width.

Important Information and Disclaimer:The information provided on this page represents TI's knowledge and belief as of the date that it is provided. TI bases its knowledge and belief on information provided by third parties, and makes no representation or warranty as to the accuracy of such information. Efforts are underway to better integrate information from third parties. TI has taken and continues to take reasonable steps to provide representative and accurate information but may not have conducted destructive testing or chemical analysis on incoming materials and chemicals. TI and TI suppliers consider certain information to be proprietary, and thus CAS numbers and other limited information may not be available for release.

In no event shall TI's liability arising out of such information exceed the total purchase price of the TI part(s) at issue in this document sold by TI to Customer on an annual basis.

TAPE AND REEL INFORMATION



QUADRANT ASSIGNMENTS FOR PIN 1 ORIENTATION IN TAPE



*All dimensions are nominal

Device	Package Type	Package Drawing	Pins	SPQ	Reel Diameter (mm)	Reel Width W1 (mm)	A0 (mm)	B0 (mm)	K0 (mm)	P1 (mm)	W (mm)	Pin1 Quadrant
THS9000DRWR	VSON	DRW	6	3000	179.0	8.4	2.2	2.2	1.2	4.0	8.0	Q2
THS9000DRWT	VSON	DRW	6	250	179.0	8.4	2.2	2.2	1.2	4.0	8.0	Q2

TAPE AND REEL BOX DIMENSIONS

*All dimensions are nominal

Device	Package Type	Package Drawing	Pins	SPQ	Length (mm)	Width (mm)	Height (mm)
THS9000DRWR	VSON	DRW	6	3000	195.0	200.0	45.0
THS9000DRWT	VSON	DRW	6	250	195.0	200.0	45.0

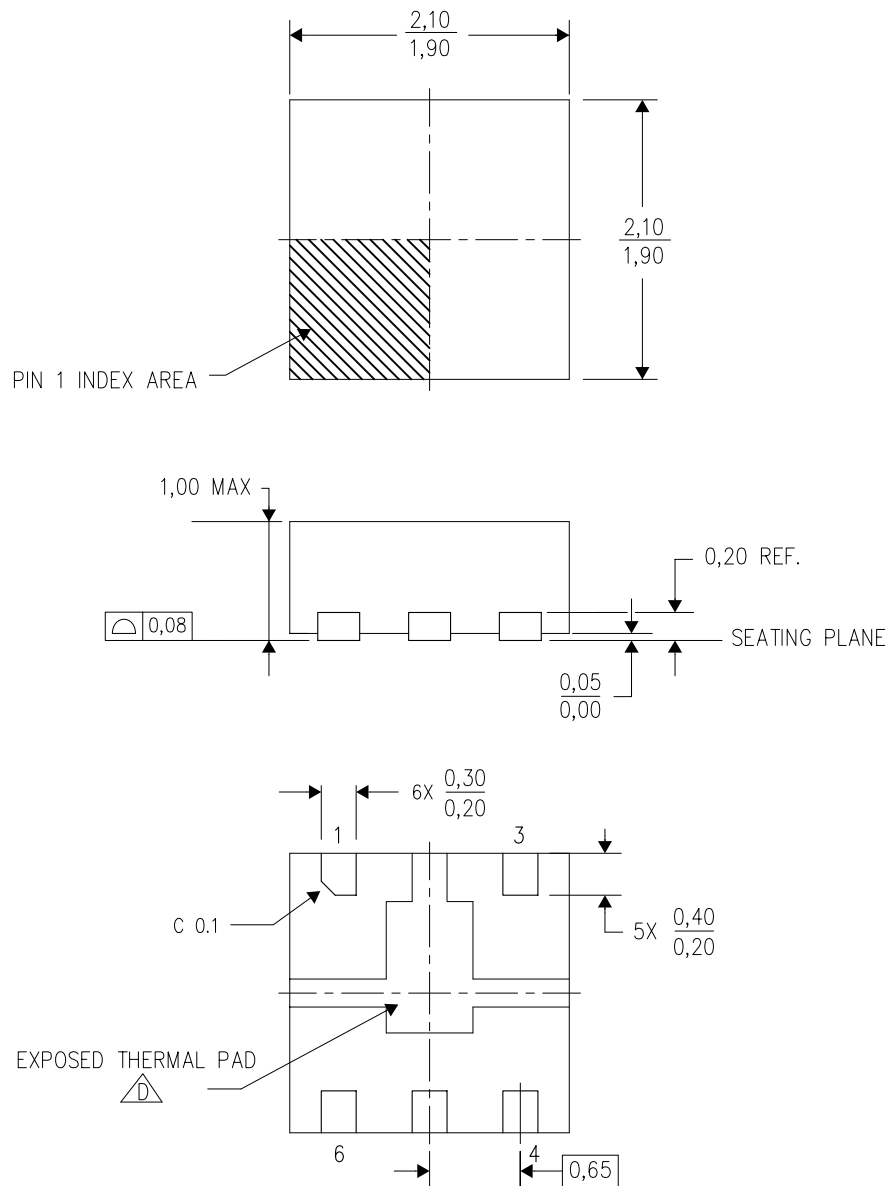

4207179/D 12/10

- NOTES:
- A. All linear dimensions are in millimeters. Dimensioning and tolerancing per ASME Y14.5-1994.
 - B. This drawing is subject to change without notice.
 - C. Small Outline No-Lead (SON) package configuration.
 -  D. The package thermal pad must be soldered to the board for thermal and mechanical performance. See the Product Data Sheet for details regarding the exposed thermal pad dimensions.

IMPORTANT NOTICE

Texas Instruments Incorporated (TI) reserves the right to make corrections, enhancements, improvements and other changes to its semiconductor products and services per JESD46, latest issue, and to discontinue any product or service per JESD48, latest issue. Buyers should obtain the latest relevant information before placing orders and should verify that such information is current and complete.

TI's published terms of sale for semiconductor products (<http://www.ti.com/sc/docs/stdterms.htm>) apply to the sale of packaged integrated circuit products that TI has qualified and released to market. Additional terms may apply to the use or sale of other types of TI products and services.

Reproduction of significant portions of TI information in TI data sheets is permissible only if reproduction is without alteration and is accompanied by all associated warranties, conditions, limitations, and notices. TI is not responsible or liable for such reproduced documentation. Information of third parties may be subject to additional restrictions. Resale of TI products or services with statements different from or beyond the parameters stated by TI for that product or service voids all express and any implied warranties for the associated TI product or service and is an unfair and deceptive business practice. TI is not responsible or liable for any such statements.

Buyers and others who are developing systems that incorporate TI products (collectively, "Designers") understand and agree that Designers remain responsible for using their independent analysis, evaluation and judgment in designing their applications and that Designers have full and exclusive responsibility to assure the safety of Designers' applications and compliance of their applications (and of all TI products used in or for Designers' applications) with all applicable regulations, laws and other applicable requirements. Designer represents that, with respect to their applications, Designer has all the necessary expertise to create and implement safeguards that (1) anticipate dangerous consequences of failures, (2) monitor failures and their consequences, and (3) lessen the likelihood of failures that might cause harm and take appropriate actions. Designer agrees that prior to using or distributing any applications that include TI products, Designer will thoroughly test such applications and the functionality of such TI products as used in such applications.

TI's provision of technical, application or other design advice, quality characterization, reliability data or other services or information, including, but not limited to, reference designs and materials relating to evaluation modules, (collectively, "TI Resources") are intended to assist designers who are developing applications that incorporate TI products; by downloading, accessing or using TI Resources in any way, Designer (individually or, if Designer is acting on behalf of a company, Designer's company) agrees to use any particular TI Resource solely for this purpose and subject to the terms of this Notice.

TI's provision of TI Resources does not expand or otherwise alter TI's applicable published warranties or warranty disclaimers for TI products, and no additional obligations or liabilities arise from TI providing such TI Resources. TI reserves the right to make corrections, enhancements, improvements and other changes to its TI Resources. TI has not conducted any testing other than that specifically described in the published documentation for a particular TI Resource.

Designer is authorized to use, copy and modify any individual TI Resource only in connection with the development of applications that include the TI product(s) identified in such TI Resource. NO OTHER LICENSE, EXPRESS OR IMPLIED, BY ESTOPPEL OR OTHERWISE TO ANY OTHER TI INTELLECTUAL PROPERTY RIGHT, AND NO LICENSE TO ANY TECHNOLOGY OR INTELLECTUAL PROPERTY RIGHT OF TI OR ANY THIRD PARTY IS GRANTED HEREIN, including but not limited to any patent right, copyright, mask work right, or other intellectual property right relating to any combination, machine, or process in which TI products or services are used. Information regarding or referencing third-party products or services does not constitute a license to use such products or services, or a warranty or endorsement thereof. Use of TI Resources may require a license from a third party under the patents or other intellectual property of the third party, or a license from TI under the patents or other intellectual property of TI.

TI RESOURCES ARE PROVIDED "AS IS" AND WITH ALL FAULTS. TI DISCLAIMS ALL OTHER WARRANTIES OR REPRESENTATIONS, EXPRESS OR IMPLIED, REGARDING RESOURCES OR USE THEREOF, INCLUDING BUT NOT LIMITED TO ACCURACY OR COMPLETENESS, TITLE, ANY EPIDEMIC FAILURE WARRANTY AND ANY IMPLIED WARRANTIES OF MERCHANTABILITY, FITNESS FOR A PARTICULAR PURPOSE, AND NON-INFRINGEMENT OF ANY THIRD PARTY INTELLECTUAL PROPERTY RIGHTS. TI SHALL NOT BE LIABLE FOR AND SHALL NOT DEFEND OR INDEMNIFY DESIGNER AGAINST ANY CLAIM, INCLUDING BUT NOT LIMITED TO ANY INFRINGEMENT CLAIM THAT RELATES TO OR IS BASED ON ANY COMBINATION OF PRODUCTS EVEN IF DESCRIBED IN TI RESOURCES OR OTHERWISE. IN NO EVENT SHALL TI BE LIABLE FOR ANY ACTUAL, DIRECT, SPECIAL, COLLATERAL, INDIRECT, PUNITIVE, INCIDENTAL, CONSEQUENTIAL OR EXEMPLARY DAMAGES IN CONNECTION WITH OR ARISING OUT OF TI RESOURCES OR USE THEREOF, AND REGARDLESS OF WHETHER TI HAS BEEN ADVISED OF THE POSSIBILITY OF SUCH DAMAGES.

Unless TI has explicitly designated an individual product as meeting the requirements of a particular industry standard (e.g., ISO/TS 16949 and ISO 26262), TI is not responsible for any failure to meet such industry standard requirements.

Where TI specifically promotes products as facilitating functional safety or as compliant with industry functional safety standards, such products are intended to help enable customers to design and create their own applications that meet applicable functional safety standards and requirements. Using products in an application does not by itself establish any safety features in the application. Designers must ensure compliance with safety-related requirements and standards applicable to their applications. Designer may not use any TI products in life-critical medical equipment unless authorized officers of the parties have executed a special contract specifically governing such use. Life-critical medical equipment is medical equipment where failure of such equipment would cause serious bodily injury or death (e.g., life support, pacemakers, defibrillators, heart pumps, neurostimulators, and implantables). Such equipment includes, without limitation, all medical devices identified by the U.S. Food and Drug Administration as Class III devices and equivalent classifications outside the U.S.

TI may expressly designate certain products as completing a particular qualification (e.g., Q100, Military Grade, or Enhanced Product). Designers agree that it has the necessary expertise to select the product with the appropriate qualification designation for their applications and that proper product selection is at Designers' own risk. Designers are solely responsible for compliance with all legal and regulatory requirements in connection with such selection.

Designer will fully indemnify TI and its representatives against any damages, costs, losses, and/or liabilities arising out of Designer's non-compliance with the terms and provisions of this Notice.